

# NEXUS 7700G2

AUTOMATIC HARDNESS TESTER

UNIVERSAL | ROCKWELL, VICKERS, KNOOP & BRINELL



# NEXUS 7700G2

## The icon of Universal hardness testing!

Revival of the NEXUS 7700G2 as the world's most popular Universal Hardness Testing machine. This next generation of the originally 1960's developed matt screen universal hardness tester with swivel system for indenters and objectives offers significant new features and benefits for its enthusiastic users.

There is a new high resolution 11 megapixels camera on board of the 7700G2 supporting a brand new, infinite type optical system. Image quality - far superior to any similar machine on the market.

Unique is the Quick Change adapter for objectives. It now takes less than 2 seconds to change the magnification objective to a larger or lower magnification at choice.

The new software platform with larger screen provides simple operation and a low learning curve.

IMPRESSIONS™ 4 also supports the use of motorized stages on the 7700G2.

Economic high-end hardness testing according to ASTM, ISO, JIS and GB standards.



### HARDNESS SCALES



**VICKERS**  
+ HVD (HVT) 500gf - 150kgf



**KNOOP** 500gf - 5kgf



**BRINELL**  
+ HBD (HBT) with AI 1kgf - 250kgf



**ROCKWELL** 3kgf - 150kgf

### CONVENIENT TEST FORCE RANGE, SUPPORTING ALL COMMON SCALES!

500gf

NEXUS 7700G2

250kgf

## HIGHLIGHTS

- 1 Load cell, Closed loop, force feedback, load application system.
- 2 Infinite color corrected optical system with autofocus (AF)
- 3 11 Megapixels, 4K+ Full HD camera system, with zoom and autofocus
- 4 22" industrial HD touchscreen, height adjustable
- 5 Two position swivel system, indenter/objective
- 6 Quick change objective adapter, change objectives in just a few seconds
- 7 Special Brinell objective BRI-LED and ringlights available
- 8 Workstage illumination and process indicators
- 9 Precision Z-axis displacement by ergonomic handwheel
- 10 Integrated (or external) high performance system controller i7 processor
- 11 Optional adjustable workpiece clamp
- 12 Manual and motorized CNC X-Y stages and/or anvils at choice
- 13 Workpiece accommodation: 340 mm (H) x 205 mm (D)





# SUPPORTED METHODS & SCALES

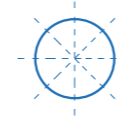

## ROCKWELL

EN-ISO 6508, ASTM E-18, JIS Z 2245

Regular Rockwell scales; Pre Load 10kgf, Main Load 60kgf | 100kgf | 150kgf

A B C D E F G H K L M P R S V

Superficial Rockwell scales; Pre Load 3kgf, Main Load 15kgf | 30kgf | 45kgf

15N 30N 45N 15T 30T 45T 15W 30W 45W 15X 30X 45X 15Y 30Y 45Y

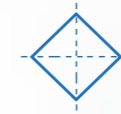

## VICKERS

DIN EN ISO 6507, ASTM E-92, ASTM E-384

HV0.5	HV1	HV2	HV2.5	HV3
HV4	HV5	HV10	HV20	HV25
HV30	HV40	HV50	HV60	HV100
HV120	HV150	+HVD		

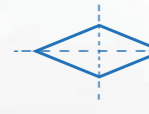

## KNOOP

DIN EN ISO 4545, ASTM E-92, ASTM E-384

HK0.5	HK1	HK2	HK5	
-------	-----	-----	-----	--



## BRINELL

DIN EN ISO 6506, ASTM E-10

HBW1/1	HBW1/1.25	HBW1/2.5	HBW1/5	HBW1/10
HBW1/30	HBW1/31.25	HBW2.5/6.25	HBW2.5/7.8125	HBW2.5/15.625
HBW2.5/31.25	HBW2.5/62.5	HBW2.5/187.5	HBW5/25	HBW 5/31.25
HBW 5/62.5	HBW5/125	HBW5/250	HBW10/100	HBW10/125
HBW10/250	+HBD			



## CONVERSIONS

DIN EN ISO 18265, DIN EN ISO 50150, ASTM E140



## METALLURGY

Grain size	DIN EN ISO 643, ASTM E112
Volume fraction	ISO 942, ASTM E562
Coating thickness	DIN EN ISO 1463

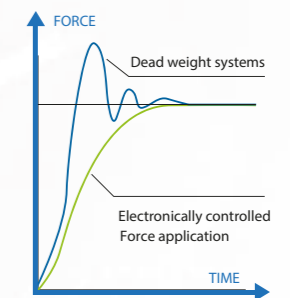

Load cell, closed loop, force feedback system

# QUICK CHANGE SYSTEM

## OPTICAL SYSTEM

The NEXUS 7700G2 new infinite optical system provides ultra sharp magnifications, excellent sharpness/depth ratio and is color corrected. The new objectives are long working distance, offering more positioning comfort to the user.

## SET OF QUICK CHANGE OBJECTIVES

Most production oriented hardness testing machines nowadays are supplied with a multi position turret. The turret that often can hold up to 9 different tools is a handy feature on the hardness tester but comes with a certain investment.

Commonly, in test laboratories there is no real production and the tester just needs to be versatile, able to do a good number of scales. Often there is the need to change objectives and this was always a hassle on non-turret machines, as objective changes came with necessary optical adjustments.

This is now a thing of the past as the NEXUS 7700G2 has been updated with a quick change lens/objective adapter on the swivel system.

In just a few seconds an objective can be changed.

All objective magnifications can be supplied with integrated ringlights or with a BRI-LED objective. No corrections or adjustments need to be made, no wires to be connected. Click out, click in.

The new quick change optical adapter provides efficient workflow as economic alternative to turrets.



## BRI-LED BRINELL EVALUATION OBJECTIVE

BRI-LED quick change objective modules improve the analysis of Brinell indentations. Commercially available objectives usually give poor performance particularly on soft Brinell indentations and therefore cause inaccurate diameter readings and incorrect results.

BRI-LED objectives provide better illumination and contrast and therefore better repeatability on measurements, regardless of material type and hardness value.

## OBJECTIVES SET





## The purpose of software is to control complexity...

For the more advanced users, for whom the standard applications would not be sufficient, IMPRESSIONS™ 4 has an unmatched level of optional “apps” that can be installed as plugins, later, at any moment. During the purchase of your tester, decide on what you need at that moment. Widen your options at any moment by a simple e-mail and a few mouse clicks, to install optional functionality. As easy or simpler than installing an app on your mobile phone.

On the shopfloor, the large landscape screens are often an unwanted component either requiring a table top or machine mounted bracket taking a lot of space and cables to deal with. IMPRESSIONS 4 leaves you the option to go for landscape or for portrait mode on a large selection of our machines.

# POWERED BY IMPRESSIONS v4

Next gen workflow & tester control...

Just buy a software release ticket, and your tester has added functionality, regardless where it is located. A revolutionary system taking care of all your needs. In this way we keep the learning curve, the process to work efficiently with our software limited to the level of “need to have” and “need to know”. The proportion of installed and activated software never needs to be higher than your requirements.

On the higher end, IMPRESSIONS 4 connects flawlessly with quality control systems such as QDAS, exports files in CVS, XML or other formats and if your requirement is not standard, our team of engineers will efficiently find ways to handle your data properly. Bespoke solutions such as connectivity to robotic systems are standard solutions for INNOVATEST™.

Unique to IMPRESSIONS™ 4 is a choice for screen size and position. Whether you wish your interface to be in portrait mode or landscape, all functionality is supported in both positions. For table top solutions like testers in laboratories, users often opt for landscape screen(s).

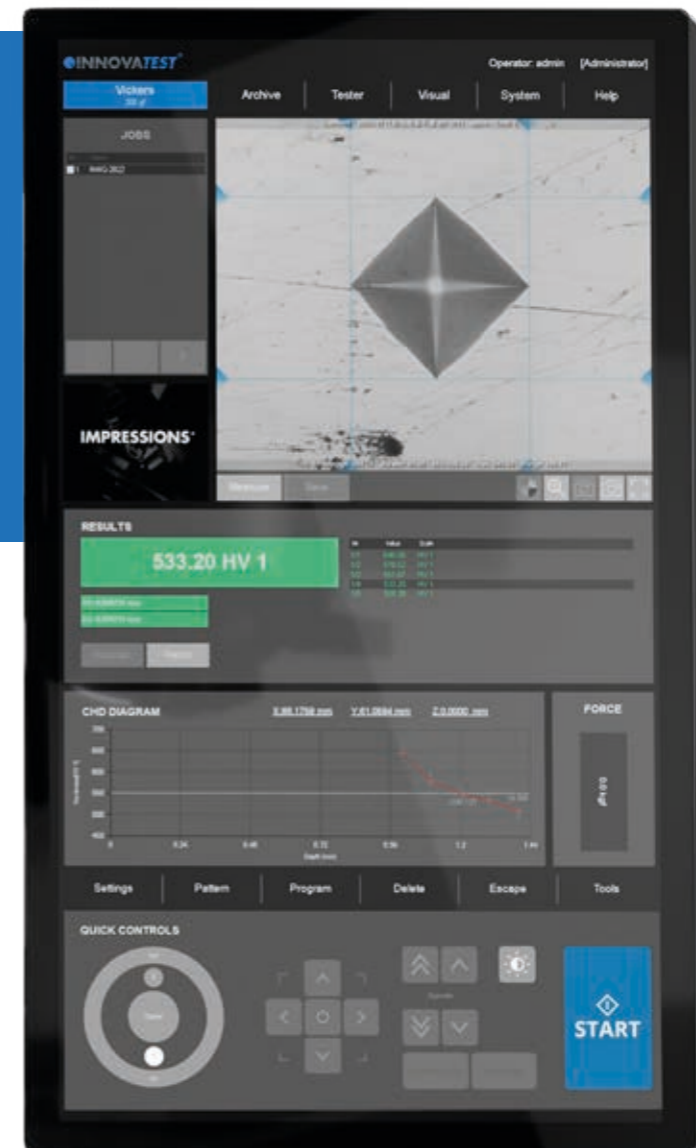

# TIME REDUCING SOFTWARE SOLUTIONS...



## 1 PATTERN EDITOR

The IMPRESSIONS™ pattern editor allows the user to create any number of test patterns with a large number of variable settings. Create test patterns with great precision and freedom. Verify the settings in the preview mode. Drag & drop patterns from one test sample to another sample. Live vision technique over zoom overview camera, no image stitching required.

Combine different patterns and even different test forces in one program, and run them fully automatically. All test points can be identified individually or to customer specifications. The label is shown in the test result list and in the test results overview and in the results print out. An important function for sample analyses at the end of a test and in the future for review of previous tests.

## 2 CHD, SHD, NHD

How do you increase throughput in your lab? Make the most common testing design as easy to set up as possible to perform automatically and still adhere to the applicable standards. CHD/SHD/NHD testing can be started directly from the surface view or from the overview. Additional core points of hardness can be defined separately for NHD measurements.

The distances of test points are automatically set to a minimum distance, following the standard, to assure correct testing is conducted. Time saving test mode "complete all indentations – then evaluate" and "auto-stop" to complete test series as soon as the lower hardness limit has been reached. Report Generator is enhanced with reporting features for this application.

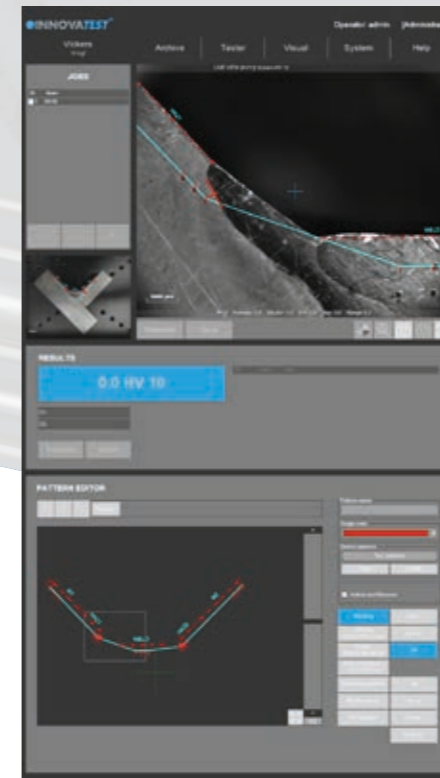
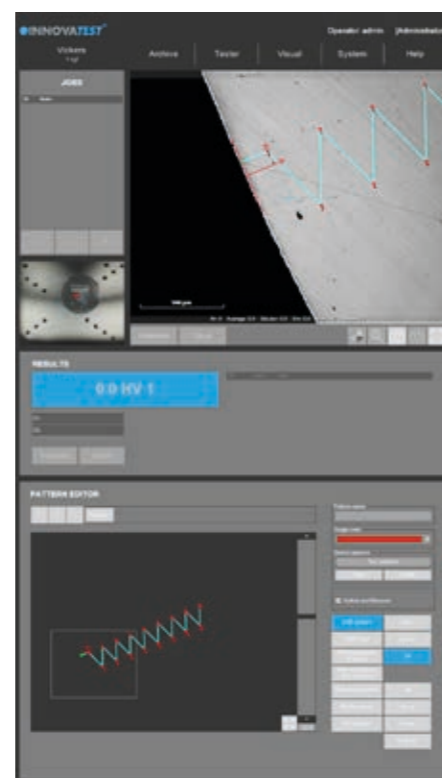

## 3 WELD INSPECTION (ISO 9015)

This especially developed tool enables you to conduct hardness testing on welded parts or segments according to ISO standard. Setting up the pattern according to the requirements becomes "easy-to-do", due to pre-set test points in the different zones of the weld and automatic correlation between test points. The system will run a fully automatic test procedure and display and record the results accordingly.

The Report Generator is enhanced with reporting features for this application.

## 4 HARDNESS OF SCREW THREAD DECARBONIZED ZONE (ISO898-1)

A specialized software tool of IMPRESSIONS™ allows you to set up and conduct fully automatic testing as per ISO898-1 for screw thread measurement of (de)-carbonized part.

The Report Generator is enhanced with reporting features for this application.

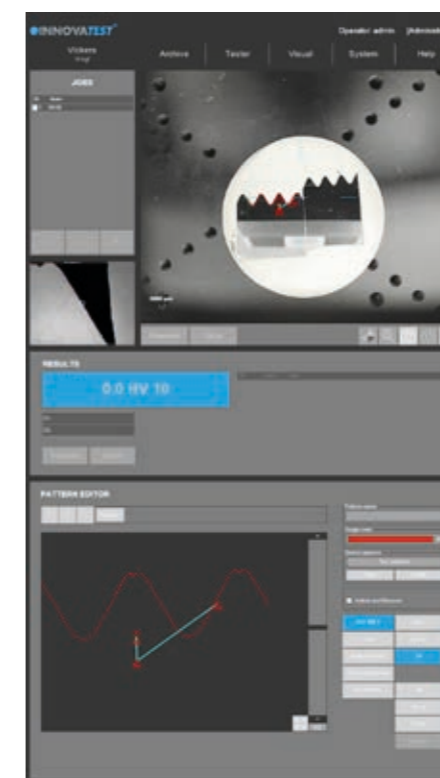



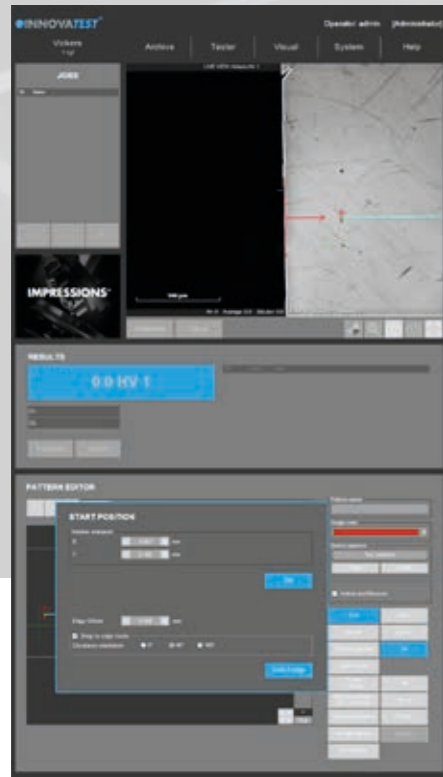

### 5 EDGE DETECTION

Technology that automatically or at a mouse click recognizes the edge of your sample. This helps to determine and fix the desired starting position for CHD or other pattern testing jobs.

### 7 2D HARDNESS CHART

The application „Plane hardness chart“, is also referred to as Color Mapping happens to be the perfect tool for securing the detail of the effective hardness distribution over the total sample cross section of heat treated samples. An important feature in material exploration, weld testing or in damage analysis.

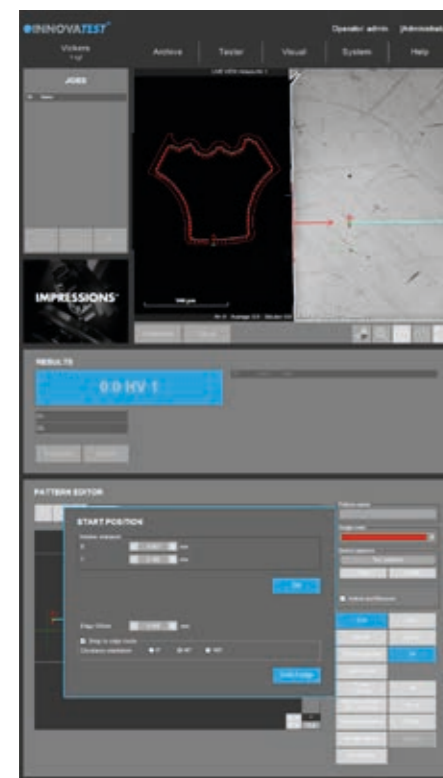
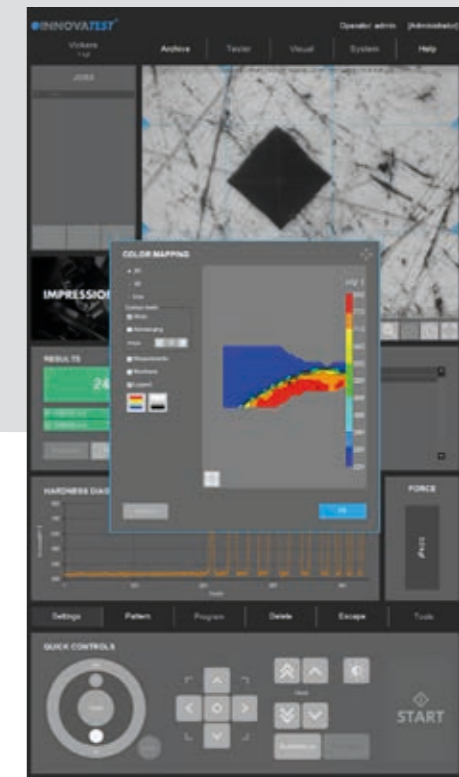

### 6 AUTOMATIC CONTOUR SCANNING

This application scans the entire outline (or partial) area of a sample. The function can be used with an objective by using the overview zoom camera for high speed scanning. The system scans the entire outline defined and stores all relevant data in the test program.

### 8 3D HARDNESS CHART

In addition to 2D graphic diagrams, the system can also automatically generate 3D diagrams. 2D and 3D hardness charts are included in one application.

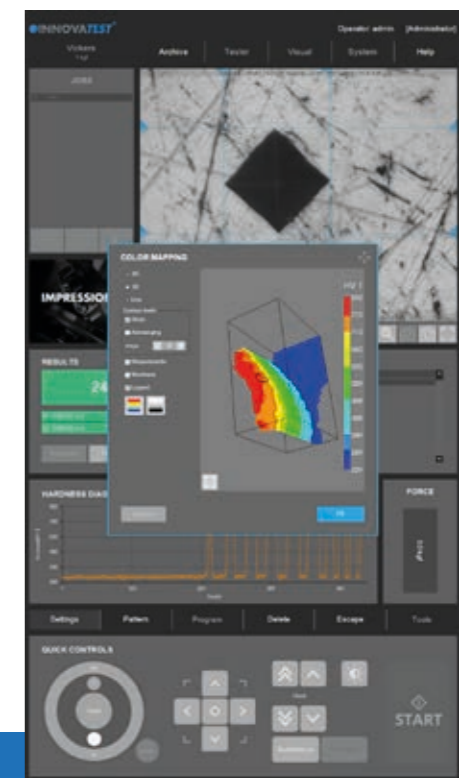

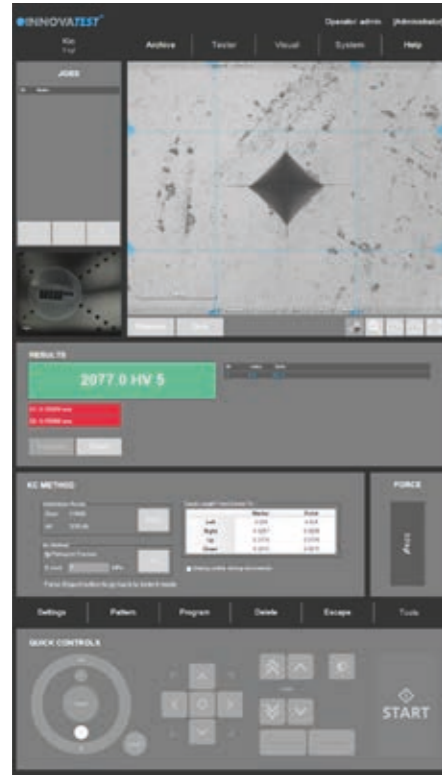

## 9 Kic CRACK MEASUREMENT

For those requiring more in depth knowledge on materials behavior, wishing to study material fracture and fatigue, crack growth can be predicted and measured by using the Kic application.

The software supports Kic crack detection under load with customized Kic result reporting. By way of one or both methods, Palmqvist or Median / Radial, fracture toughness is now a repeatable and reproducible test across multiple operators.

## 11 USER DEFINED PROGRAMS

For repeating jobs, IMPRESSIONS™ utilizes the option of setting up and storing custom test programs. For each task, a "job" can be created. All application specific parameters, such as hardness scale, force, dwell-time, pattern, conversion and the report template are stored in the same program.



## 10 SNAPSHOT FUNCTION

This handy function in IMPRESSIONS™ allows you to make screen captures of the viewing area by way of objective view and/or Overview camera. It gives the opportunity to store such images with comments or to paste them into the report generator for further processing.

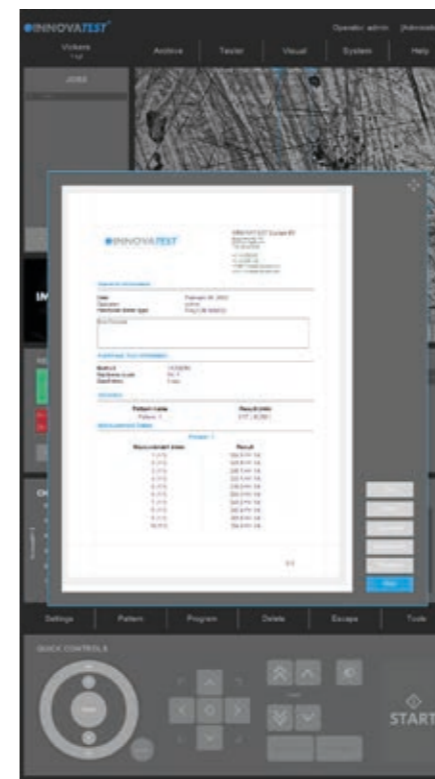

## 12 REPORT GENERATOR

Imagine having a report created for you that includes: Your company name, address, contact information, labeled results related to patterns or sequential, pictures of your optical measurements, stitched images, notes section for each result or pictures, rendition of the pattern performed, overview picture of your pattern on your sample, full statistics, summary of your results, go no-go results, Pass or fail...

All this information or having the ability to only have what you need reported, we call this our Report Configurator. You decide how much or how little you report by PDF or laser printer. We even keep it simple by choosing export to CSV file, to a thumb drive or network file location. Data management at its best!



# MONITORING

Our world is going through processes that have influence on climate and environment. More often we see extreme heat, extreme cold and periods of extreme rain. To assure that such disturbances of nature do not coincidentally effect your measuring or testing results, we have prepared our machines to climate change and forces of nature.



## 13 VIBRATION & EARTH QUAKE MONITORING

The integrated high precision accelerometer electronics continuously monitor your tester's stability environment. While the tester has vibration isolators (machine dampers) installation environment is often not ideal. Think of heavy traffic, loaded fork lift trucks, excentre presses or other equipment making shop floor installation a base of trouble.

For certain countries/area's in the world where light earthquakes are so common that they are hardly noticed, the vibration monitoring system will give a warning message and stop the hardness testing process to avoid incorrect readings.

## 14 TEMPERATURE & HUMIDITY MONITORING

Extreme high or low temperatures might not only effect the hardness readings of your machine (think of installation in extremely warm countries or nearby furnaces) extreme humidity might even damage the sensitive electronics.



# IDENTIFICATION

- 15 The basic function of the barcode reader is to load data in to determined user fields. The BAR | QR code module of INNOVATEST connects the machine to a database or network environment loading samples and data.



Whether simply inserting header files (single or serial) or the complete integration of reading devices for the automatic selection of database templates, retrieving data from connected ERP or quality systems (optional) QR and barcode readers simplify complicated work procedures for the operator.



In the above application, a turbo part has been engraved with a QR code. Extra challenging was the fact that the QR code was engraved in a high polished part of the turbo shaft.

All data for the particular turbo part was fixed in the underlying QR code. The scanner loads all customer data in the hardness testing machine and assures that the testing outcome is included in the particular test report database, fully automatic.



# METALLOSCOPE™

# METALLOGRAPHY

# SOFTWARE

The objectives on the 7700G2 make the hardness tester into an excellent highly automated metallographic microscope. Metallographic studies are of key importance in the manufacturing process of metals and steel, in the aerospace and automotive industry, in mechanical engineering, construction and in the manufacturing of a vast number of industrial and consumer products.

Microscopy is an indispensable feature of every metallographic lab, whether you investigate damages, develop novel alloy materials or perform quality control to ensure the purity of steel. The measurement of certain parameters such as volume fraction, coating thickness and grain size is specified in strict standards and norms.

Metallography is used to investigate metals from copper and titanium to iron, steel and alloys of every description. These investigations can now be performed quantitatively and reliably using the INNOVATEST Metalloscope™ 1 software module, running on most of our higher-end hardness testing machines\*. \*(features of Metalloscope™ 1 software depend on the particular tester model).

The microstructure of metals has a significant influence on properties such as strength and corrosion resistance. Therefore, a detailed investigation of the microstructure with the help of microscopy is central to metallographical disciplines as well as many industrial applications.

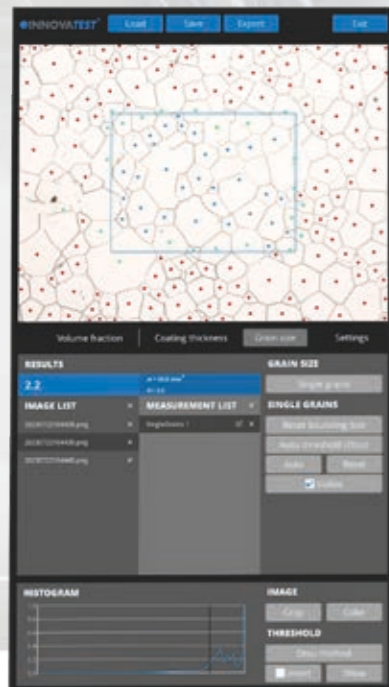

## GRAIN SIZE

**Grain size:**  
The grain size index can be calculated in various 1 or 2 dimensional way; using a 1-dimensional method (from the number of grain intercepts per mm) or a 2-dimensional method (from the number of grains per mm<sup>2</sup>). Line profile: 1-dimensional grain size index calculation by counting the number of grain intercepts on a line. Hexagonal grid: 2-dimensional grain size index calculation using a superimposed hexagonal grid or single grains calculation by counting the number of grains in a specific part of the image (blue box).

## Hardness tester and metallurgical microscope.

Basic metals undergo specific treatment in order to prepare them for particular applications and to improve their characteristics, for example by adding alloying elements. In many cases, the microscopy investigation focusses on the correlation between the resulting microstructure and the material properties.

## VOLUME FRACTION

**Volume fraction:**  
Various methods integrated; the example shows a sample consisting of ferrite (black material) and austenite (white material). Pixel counter: calculation based on histogram-guided image thresholding. Two automatic thresholding algorithms in addition to manual thresholding. Grid counter calculation using a superimposed grid. Each grid point can be assigned to the black material or white material. Initial values (black or white) are assigned automatically, but can be toggled manually. Grid positions are calculated by defining the number of grid points or the grid spacing.

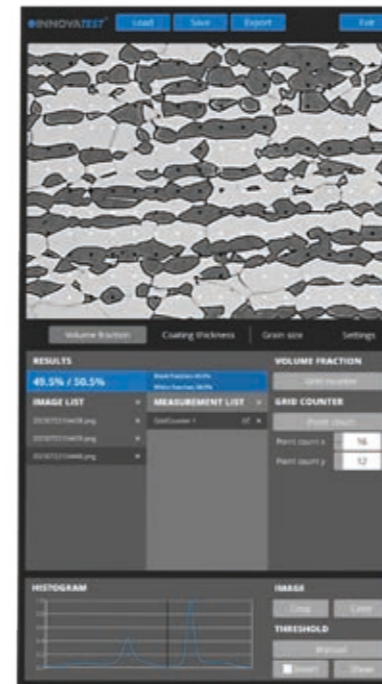

## COATING THICKNESS

**Coating thickness:**  
Calculate the thickness of a coating layer. This can be a single thickness or a mean thickness with standard deviation or a coating contour. Calculation using two parallel lines. The resulting coating thickness is the distance between these lines. Calipers can be rotated, automatic or manual. Coating contour: coating thickness calculation based on a number of measurement points. Contour edges are drawn semi-automatically and the number of measurement points can be selected by the user.





# AUTOMATIC IMAGE EVALUATION



## AUTO FOCUS

Fast & precise, observe how IMPRESSIONS™ finds focus from a large distance, as far as the travel of the Z-axis allows. Algorithms used for close distance autofocusing set new standards in AF speed.



## AUTOMATIC MEASUREMENT

Manual positioning of filar lines is no longer required. IMPRESSIONS™ refined measurement algorithms detect indents even on very poor or scratched surfaces and measure the relevant indent dimensions according to standards. Stay in control by switching to manual measure mode and have the option of adjusting measurements by touching the screen or using the mouse. Filar lines can be colored to give the best contrast against the specimen's surface. To assure that measurements meet relevant standards on symmetry, enable the automatic indent check. All hardness values can be converted to other scales according to ISO 18265, ISO 50150, ASTM E140.



## ILLUMINATION SETTINGS

IMPRESSIONS™ software automatic illumination system adapts to the correct illumination regardless of the sample surface quality, wherever on the sample, independent from material (steel, carbide, coated or ceramic). Contrast, Brightness and program, can be set automatically for each measurement or controlled manually. Sharpness can be stored with the pre-determined test.

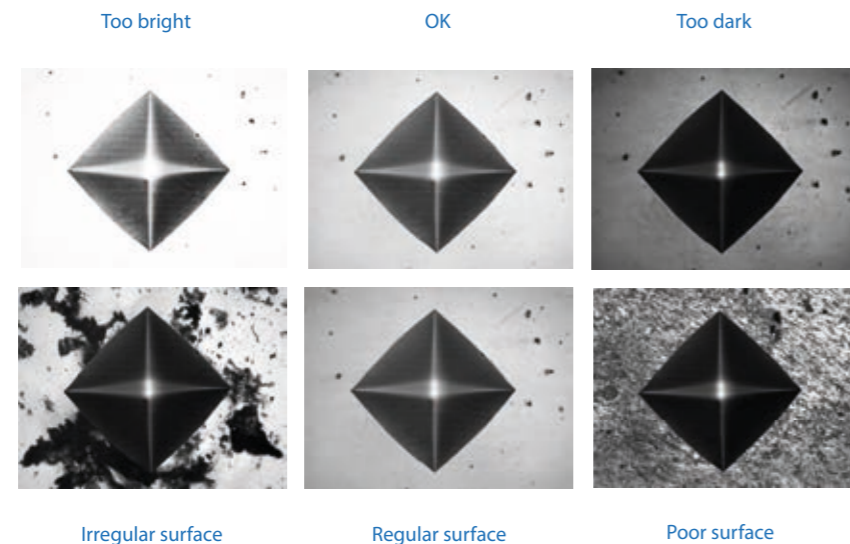

Complex, refined algorithms ensure reproducible measurements on different materials and even on scratched and damaged surfaces.

## SUPERIOR ARTIFICIAL INTELLIGENCE (AI)

We include an advanced physics development breakthrough in the image analyses of our Brinell capable hardness testing machines.

The conventional image processing methods on hardness testing machines are fairly successful for clean images that present clear indentation boundaries. In practice, however, workpieces or samples often have rough surfaces that compromise the quality of the image processing which could potentially result in incorrect hardness values.

A human observer can easily find the indentation in both images and the exact boundaries of such indentation (see fig. 1). For a computer algorithm, finding the indentation in the right image is much more challenging due to the many gradients in this image (see fig. 2). Artificial intelligence can overcome this difficulty by training a complex computer neural network to "think" as a human observer.

The INNOVATEST Brinell AI model is trained in our research facility/R&D department using powerful supercomputers. The training phase optimizes millions and millions of weight factors in a neural network, to learn how an indent can look like, using a gradient descent approach. Weight factors have been optimized by a human observer and after optimum weigh factors where determined. Using the AI function on our hardness tester to detect new indentations is called "inference" and requires significantly less computing power. The AI model has been created.

The integrated Intel® Core™ i7 processor can easily handle this task which makes it possible to install and use the INNOVATEST Brinell AI module on the NEMESIS 7700G2 as well.

During inference, a new image (a new Brinell indent image) is entered in to the neural network with weights that were determined during training (see fig. 3).

The complex algorithm is capable to calculate a "mask" on its own, this mask is plotted on top of the indent image, exactly filling the indent and marking the edges that then can be easily detected by automatic image recognition system (see fig. 4).

This super advanced technology requires no special objectives and provides even indents with poor visibility, often the case with shallow indents in rough surface materials, to be perfectly detected and measured.

The system is far superior to special objectives and standard Brinell measuring systems.

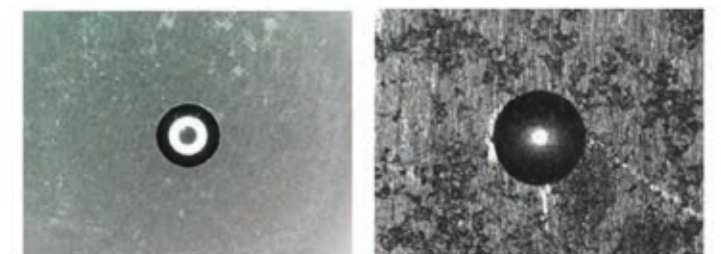

fig.1-2

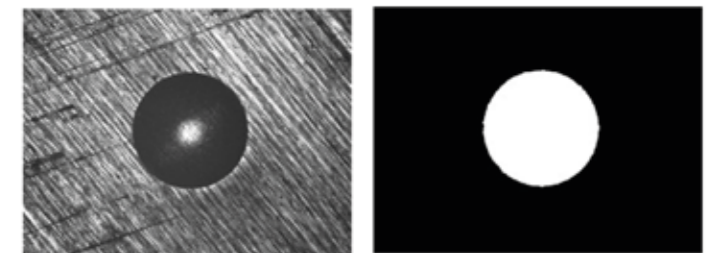

fig.3-4





# VARIOUS TESTING POSSIBILITIES

The 7700G2 has the option to install a wide variety of anvils, fixtures, flat stages, manual micrometer stages or CNC X-Y motorized stages. In combination with a load application system that ranges from 0.5kgf up to 250kgf the machines can be seen as unique in its class, with a large install base of many thousands of machines.

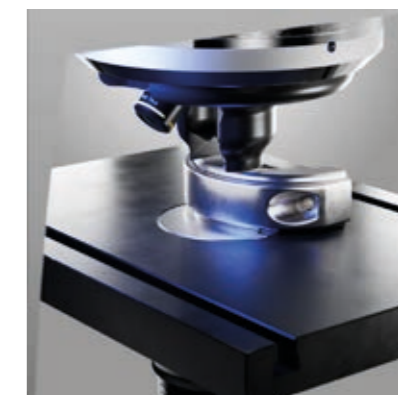
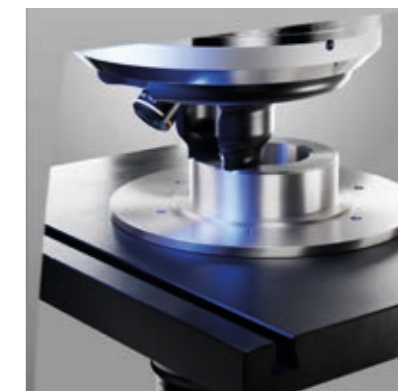
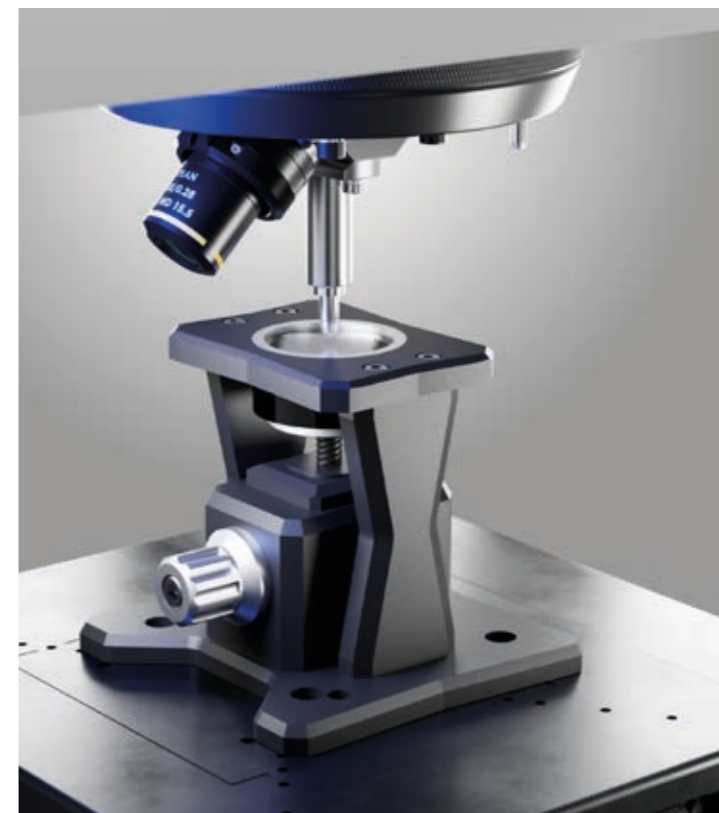

## WORKPIECE CLAMP & INDENTER COVER

The NEXUS 7700G2 can be equipped with a workpiece clamp that provides adjustable pressure on the workpiece surface and presses the workpiece firmly to the stage or anvil. The clamp also protects the indenter against unwanted damage.

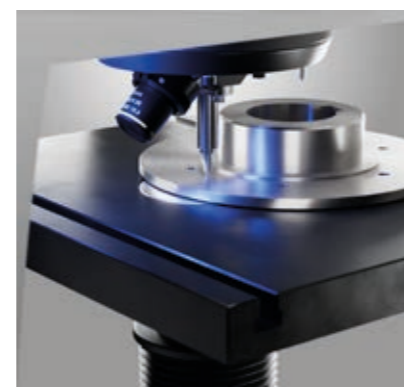
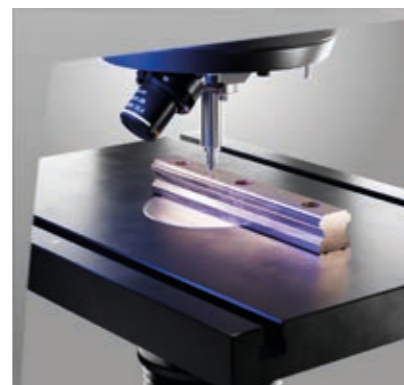





## STEP 1: Select machine type



## STEP 2: Indenters

### 1 Indenters

- A Rockwell
- B Brinell
- C Vickers
- D Knoop

## STEP 3: Optical

### 2 Objectives

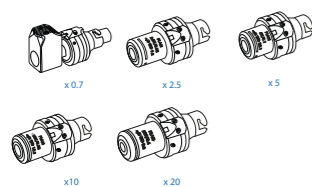

### 3 Ringlights



## STEP 4: Stages/Anvils

### 4 Stages

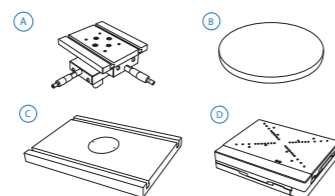

### 5 Anvils

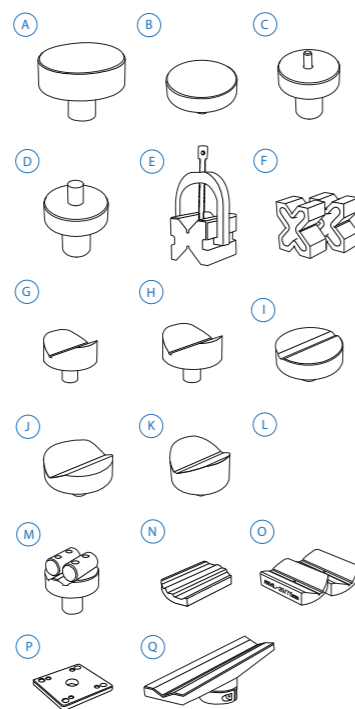

## STEP 5: Sample holders

### 6 Sample holders

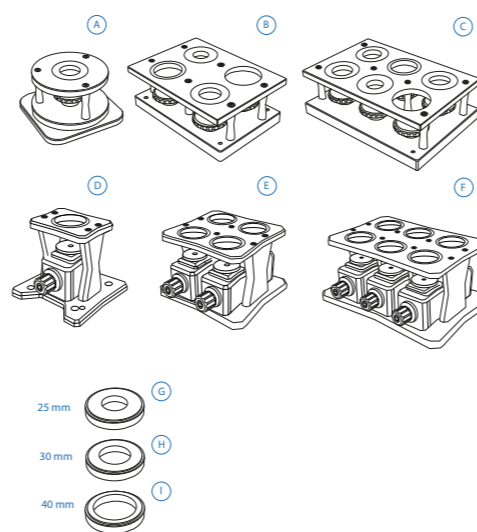

## STEP 6: Fixtures, vices & clamp

### 7 Clamp



### 8 Fixtures & Vices

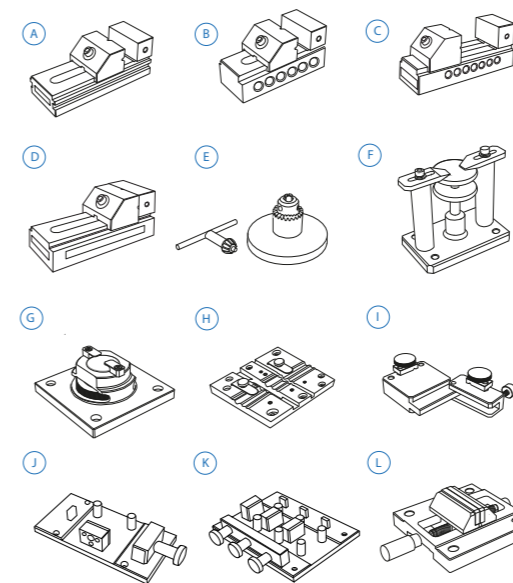

## STEP 7: Software

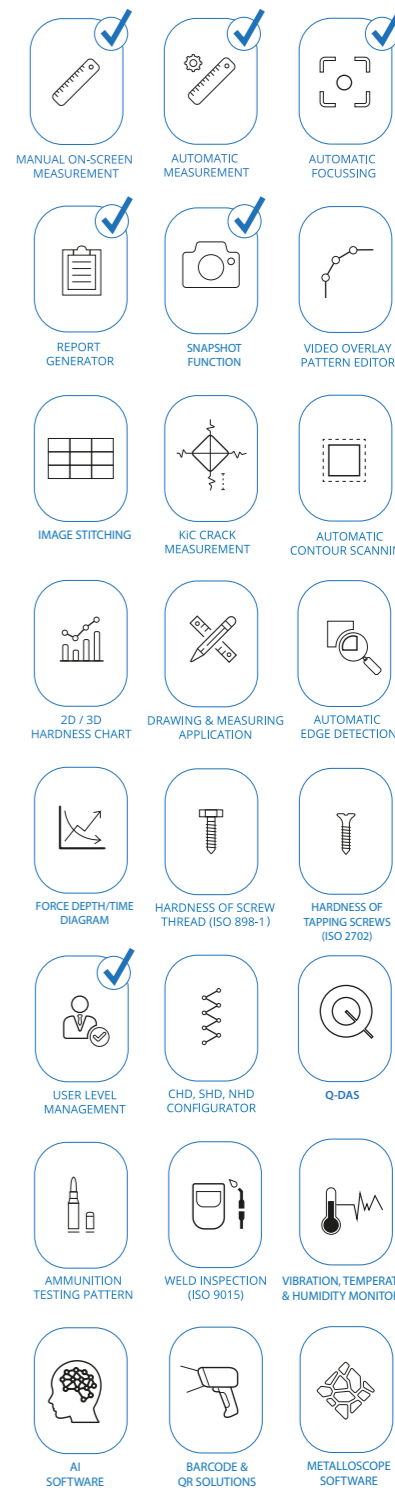

= Standard included

Not all accessories are displayed on this page. Full details can be found on the Order details page.

# ORDER DETAILS

## NEXUS 7700G2



Universal hardness tester, 500gf - 250kgf	NEXUS 7700G2	
Plug & Play prepared, calibration, sea & airworthy packing in "non coniferous wood" material	P&PSEAPACK120	
Colored led status indication	SA-05-0070	<b>STANDARD</b>

## ACCESSORIES

STEP 2	Indenters					
1	Rockwell	A	Rockwell C Diamond Indenter, ISO & ASTM certified	IN/6005		
			Rockwell Ball Indenter 1/16". Includes 1 carbide ball, ISO & ASTM certified	IN/7506		
			Rockwell Ball Indenter 1/8". Includes 1 carbide ball, ISO & ASTM certified	IN/7606		
			Rockwell Ball Indenter 1/4". Includes 1 carbide ball, ISO & ASTM certified	IN/7706		
			Rockwell Ball Indenter 1/2". Includes 1 carbide ball, ISO & ASTM certified	IN/7806		
	Brinell	B	Brinell Indenter 1mm. Includes 1 carbide ball. Ø6.35mm. ISO & ASTM certified	IN/7000		
			Brinell Indenter 2.5mm. Includes 1 carbide ball. Ø6.35mm. ISO & ASTM certified	IN/7005		
			Brinell Indenter 5mm. Includes 1 carbide ball. Ø6.35mm. ISO & ASTM certified	IN/7010		
			Brinell Indenter 10mm. Includes 1 carbide ball. Ø6.35mm. ISO & ASTM certified	IN/7015		
			Vickers	C	Macro Vickers Indenter Ø6.35mm, ISO & ASTM certified	IN/8010
Knoop	D	Macro Knoop Indenter Ø6.35mm, ISO & ASTM certified	IN/8220			
STEP 3	Optical					
2	Objectives	BRI-LED Brinell Quick change objective 0.7x	SA-05-0064			
		Quick change objective 2.5x	SA-05-0066			
		Quick change objective 5x	SA-05-0067			
		Quick change objective 10x	SA-05-0068			
		Quick change objective 20x	SA-05-0069			
3	Ringlights	Quick change ringlight 2.5x	SA-05-0071			
		Quick change ringlight 5x	SA-05-0072			
		Quick change ringlight 10x	SA-05-0073			
STEP 4	Stages/Anvils					
4	Stages	A	Manual X-Y stage with analogue metric micrometers, 180x160mm Displacement: 25x25mm, scale 0.01mm, max load 300kg	UN-TESTTABLE/030		
			Clamping, locking & fixing adapters	Lock flange	UN-XYZ BUSH55	
				Mounting plate for lock flange	UN-XYZ30FP50-55	
				B	Testing table ø200mm	UN-TESTTABLE/011
					Testing table ø235mm	UN-TESTTABLE/013
			C	Testing table ø200mm (61 - 65HRC) requires lock flange	CM-08-0194	
				Large flat surface testing table 350x250mm, thickness 30mm with 2 T-slots, for large components	UN-TESTTABLE/015	
				Large flat surface testing table 450x350mm, thickness 35mm with 2 T-slots, for large components	UN-TESTTABLE/016	

			Large flat surface testing table 600x300mm, thickness 25mm, with 2 T-slots, for large light components	UN-TESTTABLE/019	
		D	iSMART™ motorized CNC X-Y stage, 215x160mm, total load up to 400Kgf max. Displacement: 75x75mm, resolution 0.001mm, repeatability+/-0.0015mm	MA-XY7575S	
			iSMART™ stage, 260x205mm, total load up to 400Kgf max. Displacement: 120x120mm, resolution 0.001mm, repeatability+/-0.0015mm	MA-XY1212S	
			iSMART™ stage, 360x205mm, total load up to 400Kgf max. Displacement: 220x120mm, resolution 0.001mm, repeatability+/-0.0015mm	MA-XY2212S	
			iSMART™ stage, 490x224mm, total load up to 400Kgf max. Displacement: 340x120mm, resolution 0.001mm, repeatability+/-0.0015mm	MA-XY3412S	
	Cable sets, mounting & Connectivity for motorized stage		Lock flange	AS3000-21-01	
			Mounting plate for lock flange	UN-XYZ30FP50-100	
			iSMART™ X-Y stage connection cable	CE-99-0031	
5	Anvils	A	Flat anvil 60mm	AS3000-19-04	
			B	Flat anvil 80mm	UN-TESTTABLE/002
			C	Spot anvil 5mm	UN-ANVIL/010
			D	Spot anvil 10mm	UN-ANVIL/011
			E	V block with bracket 40x40x50mm (LxBxH)	UN-VBLOCK404050
			F	Steel, cross type, (X) V-block 60x120x100mm 8-90mm pair	UN-CROSSBLOCK01
			G	V-anvil ø40mm 6-60mm	UN-ANVIL/005
			H	V-anvil ø63mm 10-100mm	UN-ANVIL/006
			I	V-Anvil ø80mm 3.3-20mm	UN-ANVIL/040
			J	V-Anvil ø80mm 15-80mm	UN-ANVIL/045
			K	V-Anvil ø80mm 23-140mm	UN-ANVIL/050
			L	Anvil for spherical specimen dia. 6-25,4mm	UN-ANVIL/200
			M	Cylindrical V anvil 6-80mm	UN-CVANVIL680
				Cylindrical V anvil 50-200mm	UN-CVANVIL50200
				Test table 100x100mm, V groove 20mm wide, 10mm deep	UN-TESTTABLE/040
	N	Small V-Anvil 3-20mm requires base plate (Requires Manual/Autom. X-Y stage)	UN-ANVILSV/105		
	O	Large V-Anvil 20-75mm requires base plate (Requires Manual/Autom. X-Y stage)	UN-ANVILLV/106		
	P	Base plate for V-anvils un-anvilsv/105 & 106	UN-VANVILBASEPL		
	Q	Extra long V-Anvil (Ø10 - Ø100)	CM-08-0186		
STEP 5	Sample holders				
6	Sample holders	A	1 position sample holder, for 1 embedded sample, diameter 50mm or 2"	UN-ESH1	
		B	4 position sample holder, for max. 4 embedded samples, diameter 50mm or 2"	UN-ESH4	
		C	6 position sample holder, for max. 6 embedded samples, diameter 50mm or 2"	UN-ESH6	
		D	1 position sample holder, for 1 embedded sample, diameter 50mm or 2" with front operation elevator knob	BM-08-0052	
		E	4 position sample holder, for max. 4 embedded samples, diameter 50mm or 2" with front operation elevator knob	BM-08-0053	
		F	6 position sample holder, for max. 6 embedded samples, diameter 50mm or 2" with front operation elevator knob	BM-08-0054	



		1 insert reduction ring 25mm	UN-ESHI25	
		1 insert reduction ring 30mm	UN-ESHI30	
		1 insert reduction ring 40mm	UN-ESHI40	
		1 insert reduction ring 1"	UN-ESHI1	
		1 insert reduction ring 1 1/4"	UN-ESHI125	
		1 insert reduction ring 1,5"	UN-ESHI15	
<b>STEP 6</b>	<b>Fixtures, vices &amp; clamp</b>			
<b>7</b>	Clamp	Clamping nose assembly	SA-02-0128	
<b>8</b>	Fixtures & vices	<b>A</b> Polished precision vice with lock down system, jaw width 25mm, opens 20mm	UN-VICE/210	
		<b>B</b> Polished precision vice with lock down system, jaw width 36mm, opens 42mm	UN-VICE/215	
		<b>C</b> Polished precision vice with lock down system, jaw width 48mm, opens 75mm	UN-VICE/220	
		<b>D</b> Polished precision vice with lock down system, jaw width 75mm, opens 100mm	UN-VICE/230	
		<b>E</b> Axle chuck 500 series for cylinder parts, dia. 0.4mm to 5mm	UN-AXLECHUCK	
		<b>F</b> Universal Clamp & Leveling Device	UN-CLAMP/105	
		<b>G</b> Thin metal clamp	UN-CLAMP/115	
		<b>H</b> V groove clamp for small round parts dia.0.8-5mm	UN-VGROOVE- CLAMP	
		<b>I</b> Wire Testing Fixture for specimen dia. 0.8-3.5mm	UN-WIRE/105	
		<b>J</b> JOMINY Fixture, for 1 quench end test sample, quick release function	UN-JOMFIX1	
		<b>K</b> JOMINY Fixture, for 3 quench end test sample, quick release function	UN-JOMFIX3	
		<b>L</b> Small parts vice jaw width 55mm, open 50mm, self centering	UN-VICE/115	
	<b>Software</b>			
	Additional software	Manual on-screen measurement	UN-MANM	<b>STANDARD</b>
		Automatic measurement	UN-AUTOM	<b>STANDARD</b>
		Automatic focussing	UN-AUTOFOC	<b>STANDARD</b>
		Report configurator	UN-REPORTA	<b>STANDARD</b>
		Snapshot function	UN-SNAPSH	<b>STANDARD</b>
		Advanced 3 axis coordinate & free style indent pattern configurator, for motorized stage only	UN-TESTPAT01	
		Advanced 3 axis coordinate & free style indent pattern configurator, + CHD, SHD, NHD and edge detection, (supports manual & digital micrometer stages only)	UN-TESTPAT02	
		Image stitching, composes full stage overview, and detailed sample overview in high resolution. Requires a motorized stage.	UN-IMST01	
		KiC crack detection under load. Palmqvist & Median / Radial fracture toughness	UN-CRKPAP	
		Automatic Contour scanning	UN-CSCAN	
		2D / 3D hardness scanning (mapping, includes automatic contour scanning)	UN-CSCAN2D3D	
		Drawing and measuring (distance & angles) application	UN-DRMEAS	
		Automatic edge detection	UN-EDGEDTC	
		Force depth/time diagram	UN-FDDIAGR	
		ISO898-1 screw thread measurement of (de)-carbonized part. Requires UN-CSCAN	UN-ISO898/1	
		ISO-2702 tap screw thread measurement	UN-ISO2702	
		User level management	UN-LEVMAN	<b>STANDARD</b>

		CHD, SHD, NHD configurator & graphic interface for analogue and digital micro meter stage only (not including full pattern editor)	UN-MCHD	
		CHD, SHD, NHD configurator & graphic interface requires: indent pattern configurator (TESTPAT01)	UN-PATCHD	
		Q-DAS Certified connectivity protocol	UN-QDAS	
		Advanced 3-axis communication protocol for robotic systems	UN-REMC	
		ISO bullets casings pattern configurator and reporting system	UN-SHELLCONF	
		Vibration, temperature & humidity monitoring	UN-VIBCLC	
		Artificial Intelligence Deep Learning Brinell module	UN-AIDL01	
		Barcode & QR data mapping software	UN-SCANFLOW	
		Metalloscope™ Metallography software pack	UN-MSCP01	
	Connectivity plus	Bluetooth connectivity	UN-BTADAPT	
		Utility software; Import test results in MS applications like Excel	UN-SW/905	
		USB to USB null modem cable 2.5M	BE-99-0025	
		Wireless system Keyboard & wireless mouse	UN-SKBSET	<b>STANDARD</b>
		Virtual joystick, on screen		<b>STANDARD</b>
	Machine stand	Cabinet test table with drawer for hardness testers 71x75x70cm	UN-STAND/950	
		Seaworthy packing box for 950/960	PACK/100	
	Printer	Laser Printer	UN-PRINT	
	Projector	On request, any brand of choice	UN-PROJECTOR	
		UKAS EN   ISO 17025 Direct/Indirect calibration report	CCERTFEE/UKAS	
	<b>ISO 17025 UKAS</b> ISO / ASTM Calibration	BRINELL direct and indirect calibration & certification, traceable, in compliance with ISO & ASTM, NADCAP. Includes direct force and indirect verification report (block readings), report, flat fee for selected common scales, per scale.	CCERTUKAS/1B	
	<b>ISO 17025 UKAS</b> ISO / ASTM Calibration	VICKERS direct and indirect calibration & certification, traceable, in compliance with ISO & ASTM, NADCAP. Includes direct force and indirect verification report (block readings), report, flat fee for selected common scales, per scale.	CCERTUKAS//1V	
	<b>ISO 17025 UKAS</b> ISO / ASTM Calibration	KNOOP direct and indirect calibration & certification, traceable, in compliance with ISO & ASTM, NADCAP. Includes direct force and indirect verification report (block readings), report, flat fee for selected common scales, per scale.	CCERTUKAS/1K	
	<b>ISO 17025 UKAS</b> ISO / ASTM Calibration	ROCKWELL direct and indirect calibration & certification, traceable, in compliance with ISO & ASTM, NADCAP. Includes direct force and indirect verification report (block readings), report, flat fee for selected common scales, per scale.	CCERTUKAS/1R	
	Cover	Machine cover 600x700x1000mm	UN-COVER5	

# ACCESSORIES

## INDENTERS

### Indenters



## OPTICAL

### Objectives



### Ringlights



## STAGES/ANVILS

### Stages



### Anvils



## STAGES/ANVILS

### Anvils



## SAMPLE HOLDERS

### Sample holders - Regular model

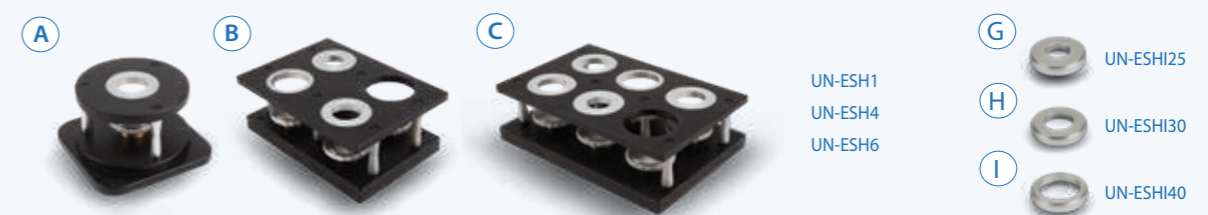

### Sample holders - Front operation



## CLAMP



## FIXTURES & VICES

### Fixtures & vices





## FIXTURES & VICES



## MACHINE STAND



UN-STAND/950

## COVER



UN-COVERS

# SPECIFICATIONS

## HARDNESS SCALES

	<b>ROCKWELL</b> EN-ISO 6508 ASTM E-18 JIS Z 2245	Regular Rockwell scales; Pre Load 10kgf, Main Load 60kgf   100kgf   150kgf A   B   C   D   E   F   G   H   K   L   M   P   R   S   V Superficial Rockwell scales; Pre Load 3kgf, Main Load 15kgf   30kgf   45kgf 15N   30N   45N   15T   30T   45T   15W   30W   45W   15X   30X   45X   15Y   30Y   45Y
	<b>VICKERS</b> ISO 6507 ASTM E384, E92 JIS B 7725	HV0.5   HV1   HV2   HV2.5   HV3   HV4   HV5   HV10   HV20   HV25   HV30   HV40   HV50 HV100   HV120   HV150
	<b>Kic Fracture toughness</b>	All Vickers forces & scales
	<b>KNOOP</b> ISO 4545 ASTM E92 JIS Z 2251	HK0.5   HK1   HK2   HK5
	<b>BRINELL</b> ISO 6506, ASTM E10 JIS Z 2243	HBW1/1   HBW1/1.25   HBW1/2.5   HBW1/5   HBW1/10   HBW1/30   HBW1/31.25 HBW2.5/6.25   HBW2.5/7.8125   HBW2.5/15.625   HBW2.5/31.25   HBW2.5/62.5 HBW2.5/187.5 HBW5/25   HBW5/31.25   HBW5/62.5   HBW5/125   HBW5/250 HBW10/100   HBW10/125   HBW10/250
	<b>PLASTIC</b> ISO 2039	49 N, 132 N, 358 N, 961 N
	<b>CARBON</b>	HR 2.5/7 HR 5/7   HR 5/20   HR 5/40   HR 5/60   HR 5/100   HR 5/150 HR 10/20   HR 10/40   HR 10/60   HR 10/100   HR 10/150
<b>HVD (HVT)</b> <b>HBD (HBT)</b>	HV5   HV10   HV20   HV25   HV30   HV50   HV60   HV100   HV120   HV150 HBW1/5   HBW1/10   HBW1/30 HBW2.5/6.25   HBW2.5/7.8125   HBW2.5/15.625   HBW2.5/31.25   HBW2.5/62.5   HBW2.5/187.5 HBW5/25   HBW5/31.25   HBW5/62.5   HBW5/125   HBW5/250 HBW10/100   HBW10/125   HBW10/250	
<b>CONVERSIONS</b>	Conversion to other hardness scales according to ASTM E140, ISO 18265, GB/T 1172	
<b>METALLURGY</b>	Grain size      DIN EN ISO 643, ASTM E112 Volume fraction    ISO 942, ASTM E562 Coating thickness    DIN EN ISO 1463	

# TECHNICAL DRAWINGS

## TEST FORCE

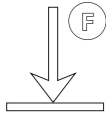
	<b>Force application</b>	Loadcell Closed loop, force feedback system
	<b>Test forces</b>	0.5kgf – 250kgf
	<b>Test force tolerance</b>	< 0.5%
	<b>Dwell time settings</b>	1 - 999 seconds

## SYSTEM

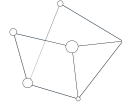
	<b>Electronic system Standard (Recommended)</b>	High performance embedded controller, i7, mSSD 120 GBxx, MS Windows® 10 operated , up to 8 years* INNOVATEST warranty
	<b>Electronic system (Optional)</b>	High performance external controller, i9, mSSD 120 GBxx, MS Windows® 10 operated, 1 year factory warranty
	<b>Screen(s)</b>	22" full colour touchscreen
	<b>Display resolution</b>	0.01 HV, HK, HB
	<b>Statistics</b>	Total test, max, min, average, range, standard deviation, All in real time after each test
	<b>Hardness conversion</b>	Rockwell, Rockwell Superficial, Vickers, Brinell, Knoop, Leeb & Tensile
	<b>Software</b>	No. of tests, Mean, St. Deviation, Min., Max., Range, CP, CPk, individual readings list, storage memory, Dwell time, test force setting, scale selection, calibration etc.
	<b>Data output</b>	XML, CSV, Certified for Q-DAS (Optional)
	<b>Connectivity</b>	4 USB ports, RJ45 Ethernet LAN, W-LAN, RS-232, Bluetooth

## GENERAL

	<b>Machine dimension</b>	687mm x 670mm x 1130mm
	<b>Machine weight</b>	190 kg
	<b>Workpiece accommodation</b>	340mm (H) x 205mm (D)
	<b>Power supply</b>	100VAC to 240VAC, 50/60Hz, single phase
	<b>Operating temperature</b>	10°C to 35°C
	<b>Power consumption</b>	100W
	<b>Humidity</b>	10% to 90%, non-condensing
	<b>Noise emission</b>	< 70 db(A)

\* Check individual warranty conditions

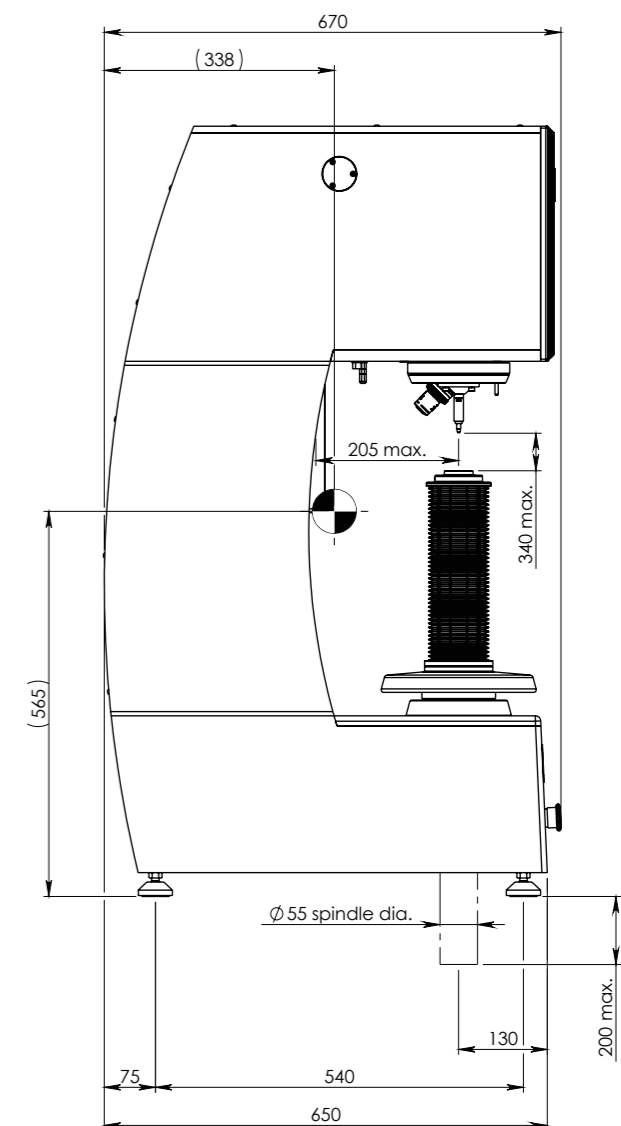
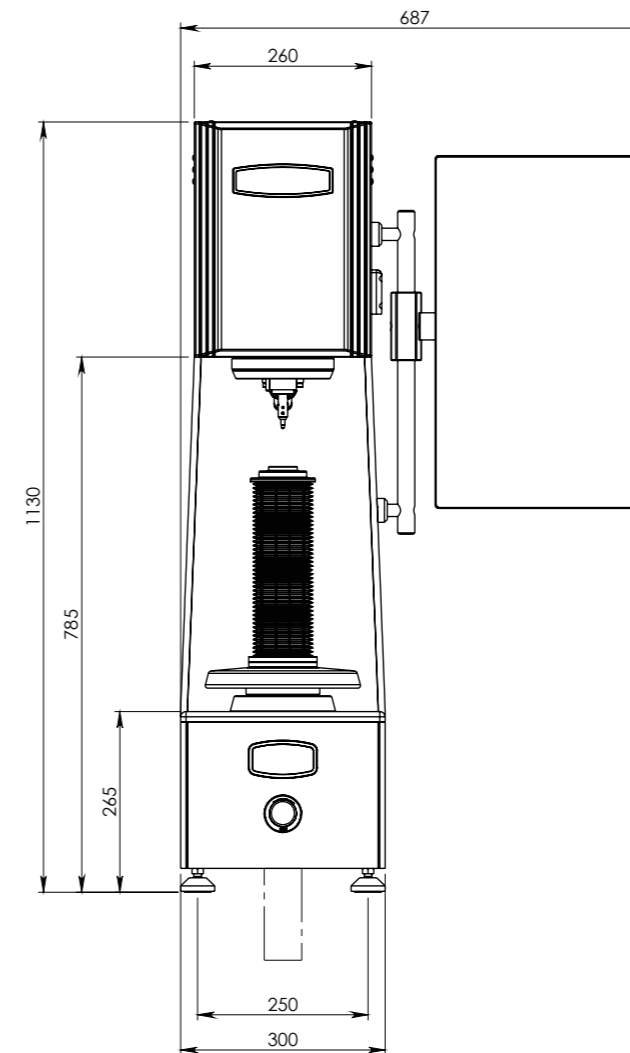

All dimensions in these drawings are in mm, approximate. Working heights and or workpiece accommodation varies depending on the stages and stage accessories used.

Please contact our sales department for more details.



## OTHER MODELS IN THE UNIVERSAL RANGE



### VERZUS 750U

Fully automatic, load cell, Closed loop, force feedback universal hardness tester with electronic micrometer or analogue eyepiece. IMPRESSIONS™ 8.5" full color touchscreen.  
See brochure B19V750U/XX



### FENIX 300U

Load Cell, Closed loop, force feedback, test force application system Universal hardness tester with I-TOUCH™ system.  
See brochure B20F300/XX



### NEXUS 8100

Heavy duty fully automatic, load cell, Closed loop, force feedback universal hardness tester with full HD optical zoom stage overview camera, IMPRESSIONS™ 15" full color touchscreen.  
See brochure B19N8100/XX

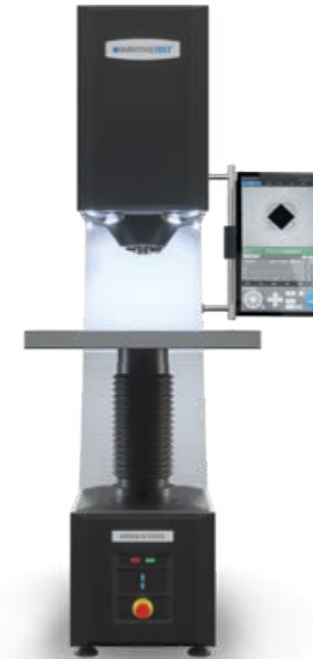

### NEXUS 8100XL

Heavy duty fully automatic, load cell, Closed loop, force feedback universal hardness tester with full HD optical zoom stage overview camera, IMPRESSIONS™ 15" full color touchscreen.  
See brochure B19N8100/XX



### NEMESIS 5100G2

Multi load cell, Closed loop Fully automatic, 8 position turret Rockwell, Superficial Rockwell, Micro/Macro Vickers, Knoop & Brinell Hardness testers Descending test head, 150 mm fixed work piece position.  
See brochure B23N5100G2/XX



### NEMESIS 9100G2

Multi load cell, Closed loop Fully automatic, 8 position turret Rockwell, Superficial Rockwell, Micro/Macro Vickers, Knoop & Brinell Hardness testers Descending test head, 300 mm fixed work piece position.  
See brochure B23N9100G2/XX

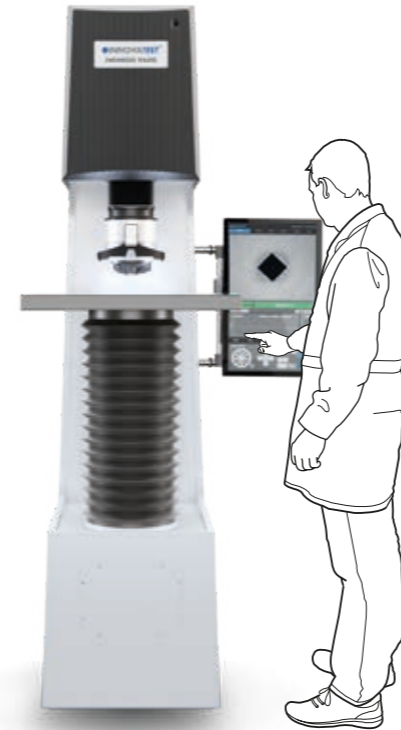

### NEMESIS 9600

Heavy duty fully automatic, load cell, Closed loop, force feedback universal hardness tester with full HD optical zoom stage overview camera, IMPRESSIONS™ 15" full color touchscreen.  
See brochure B19N9600/XX

Changes in products and/or product specifications can emerge due to new technologies and continuous development.

We reserve the right to change or modify specifications of the products without prior notice. We recommend you to contact our sales office for up-to-date information.

Brochure B23N7700G2/01/EN

© All rights reserved, 2023

## EUROPE

**INNOVATEST Deutschland GmbH.**  
**Sales & Service**  
Phone: +49 245 670 59 500  
info@innovatest-deutschland.com  
www.innovatest-deutschland.com

**INNOVATEST France SARL**  
**Sales & Service**  
Phone: +33 1 848 88038  
commercial@innovatest-france.com  
www.innovatest-france.com

**INNOVATEST UK Ltd.**  
**Sales & Service**  
Phone: +44 (0) 121 824 4775  
info@innovatest-uk.com  
www.innovatest-uk.com

**INNOVATEST Polska sp. z o.o**  
**Sales & Service**  
Phone: +48 697 099 826  
info@innovatest-polska.pl  
www.innovatest-poland.com

## MIDDLE EAST

**INNOVATEST Middle East LLC**  
**Sales & Service**  
Phone: +971- 4- 880 0875  
info@innovatest-mideast.com  
www.innovatest-mideast.com

## NORTH-AMERICA

**INNOVATEST USA Inc.**  
**Sales & Service**  
Phone: +1 267 317 4300  
info@innovatest-usa.com  
www.innovatest-usa.com

## ASIA

**INNOVATEST Shanghai Co., Ltd.**  
**Sales & Service**  
Phone: +86 21 60906200  
Fax: +86 21 60912595  
info@innovatest-shanghai.com  
www.innovatest-shanghai.com

**INNOVATEST Japan Co., Ltd.**  
**Sales & Service**  
Phone: +81 3 3527 3092  
Fax: +81 3 3527 3093  
info@innovatest-japan.com  
www.innovatest-japan.com

**INNOVATEST South East Asia**  
**Sales & Service**  
Phone: +65 6451 1123  
Fax: +65 6452 1011  
info@innovatest-singapore.com  
www.innovatest-singapore.com

Distributor :

## CORPORATE HEAD OFFICE

**INNOVATEST Europe BV**  
**Manufacturing, Distribution & Service**  
Borgharenweg 140  
6222 AA MAASTRICHT  
The Netherlands

Phone: +31 43 3520060  
Fax: +31 43 3631168  
info@innovatest-europe.com  
**www.innovatest-europe.com**