

Living up to Life

Leica
MICROSYSTEMS

Leica DCM8

Get the full picture for 3D surface metrology



Get the Full Picture for 3D Surface Metrology

Highly accurate surface analysis is essential in industry and research to help ensure optimal performance of materials and components. But there are challenges: surfaces can be made up of intricate structures with highly sloping areas demanding lateral resolution of a few microns, or critical micro peaks and valleys requiring vertical analysis on the sub-nanometer scale. While confocal microscopy offers high lateral resolution, interferometry is required to reach sub-nanometer vertical resolution.

This is why the Leica DCM8 unites both measurement techniques into one versatile, super-fast 3D surface measurement system – delivering one solution for all your metrology observation tasks.

Your Advantages:

VERSATILE AND ACCURATE – MEETING YOUR SPECIFIC SURFACE METROLOGY NEEDS

- Optimal lateral resolution, slope solving and imaging with confocal microscopy in High Definition (HD)
- Optimal vertical resolution up to 0.1 nm with HD interferometry
- Simple image capture with brightfield and darkfield microscopy
- Four LEDs for RGB HD color imaging and wider application range
- Three methods for measuring thick and thin films
- The right configuration and objective for your sample

FAST, SIMPLE AND DURABLE – LESS TIME, MONEY AND EFFORT FOR MAXIMUM RESULTS

- No need to prepare samples or swap instruments
- Fast, reliable digital HD confocal scanning
- Capture large surfaces quickly with large FOV and topography stitching
- Intuitive 2D and 3D software for data acquisition and analysis

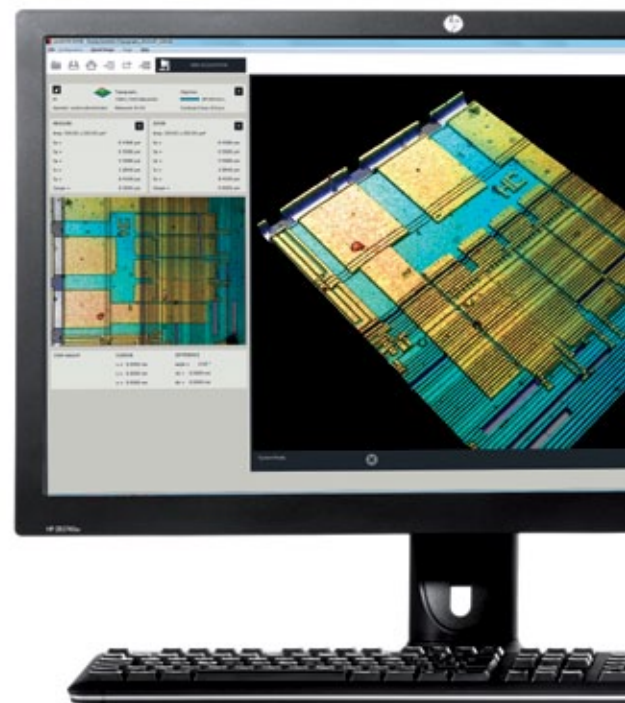

“Thanks to the Leica DCM system we can now offer topographic measurement services for the first time. As a result we have gained a number of new projects and customers.”

Stephan Ramseyer, IMA, Haute Ecole Arc Ingénierie, La Chaux-de-Fonds, Switzerland



Read more about 3D surface metrology applications or share your expertise with our community
www.leica-microsystems.com/science-lab



Shown with optional antivibration table

Versatile and Accurate – to Meet Your Specific Surface Metrology Needs

The Leica DCM8 unites the advantages of HD confocal microscopy and interferometry with a wealth of additional features that facilitate the accurate and reproducible characterization of multiple material surfaces. To meet your documentation needs, the system delivers impressive true color imaging thanks to its integrated Megapixel CCD camera and 4 LED light sources.

OPTIMAL LATERAL RESOLUTION WITH HD CONFOCAL MICROSCOPY

With confocal technology even surfaces with complex shapes or steep inclinations of up to 70° can be quickly and accurately profiled – without destroying the sample. The high resolution, high sensitivity detector of 1.4 million pixels at the heart of the Leica DCM8 allows viewing of the confocal live image or confocal and brightfield in parallel. Comprehensive surface data and a high contrast, in-focus image are quickly captured. In addition, the RGB confocal mode provides a fast impression of height distribution in real time.

You'll be quick

At the touch of a button, the sample is scanned vertically so that every point on the surface passes through the focus. Within seconds the Leica DCM8 acquires multiple confocal images at different vertical points along the objective's depth of focus, automatically adjusting illumination if required. Out of focus information is then eliminated and a detailed profile of the surface topography generated.

You'll be accurate

The confocal sensor head has no moving parts for increased stability and noise reduction thus enabling higher resolution to be achieved. By selecting a high numerical aperture (NA) of up to 0.95* and high magnification, lateral resolution up to 140 nm plus vertical resolution up to 2 nm is achieved. This method is therefore suited to material research and quality control across industries as diverse as automotive, microelectronics, medical device and aerospace.

* Higher NA can be achieved using other medias than air (immersion fluids such as water, oil, glycerin)

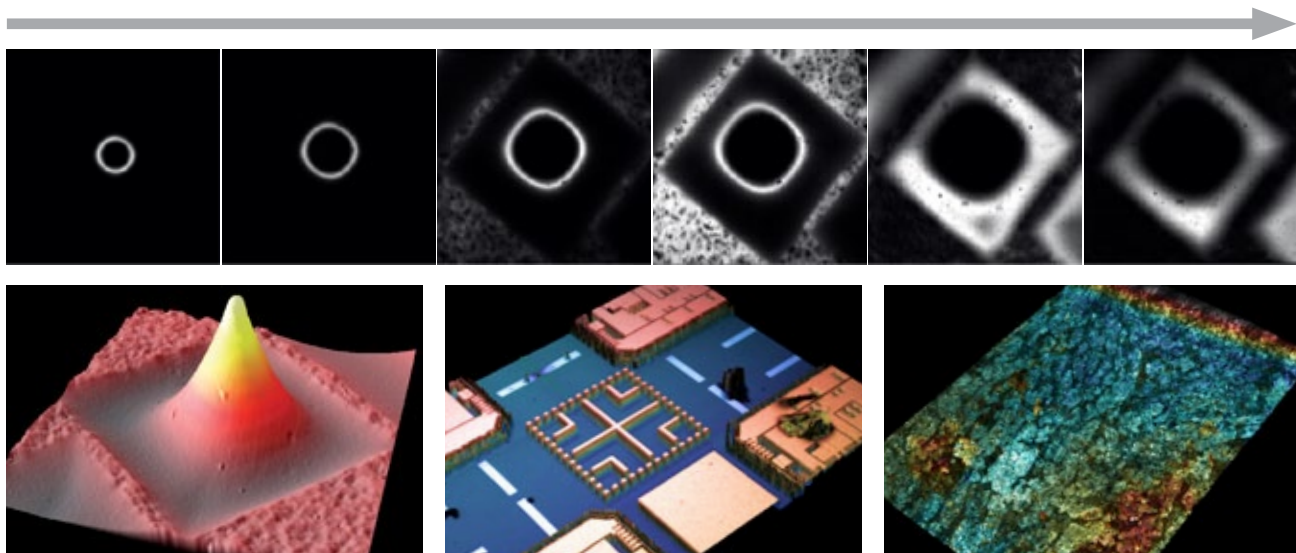

Steps of a confocal scan of a bump on a wafer surface

The final image of the scan shown above

Wafer surface

Metallic surface

OPTIMAL VERTICAL RESOLUTION WITH HD INTERFEROMETRY

When vertical resolution up to 0.1 nm is required, the Leica DCM8 interferometry mode is a perfect choice. The system is able to analyze smooth, ultra-smooth and ultra-polished surfaces, covering a wide range of applications with only one system. To meet different needs, including analysis of reflective surfaces, we offer a full range of unique high quality interferometry objectives at 5x, 10x, 20x and 50x magnification.

You'll have the choice

Depending on your sample topography, you can choose between three modes of interferometry: Vertical Scanning Interferometry (VSI) also known as White Light Interferometry (WLI) for smooth to moderately rough surfaces; Phase Shift Interferometry (PSI) for extremely smooth surfaces; and Extended PSI (ePSI) for an extended Z analysis range. VSI is ideal for measuring polished

surfaces with medium roughness at high speed. As in confocal mode, the sample is scanned vertically in steps so that every point on the surface passes through the focus, with the maximum fringe contrast occurring at the optimal focus position for each point on its surface. The height of the surface at each pixel location is found by detecting the peaks of the narrow fringe envelopes.

For ultra-polished and super smooth surfaces, such as a mirror-like bare wafer, PSI and ePSI can obtain texture parameters with sub-nanometer resolution in less than 3 seconds. To achieve such high resolution, the focused sample is scanned vertically in steps that are very accurate fractions of the wavelength. The profiling algorithms produce a phase map of the surface, which is converted to the corresponding height map via an unwrapping procedure.

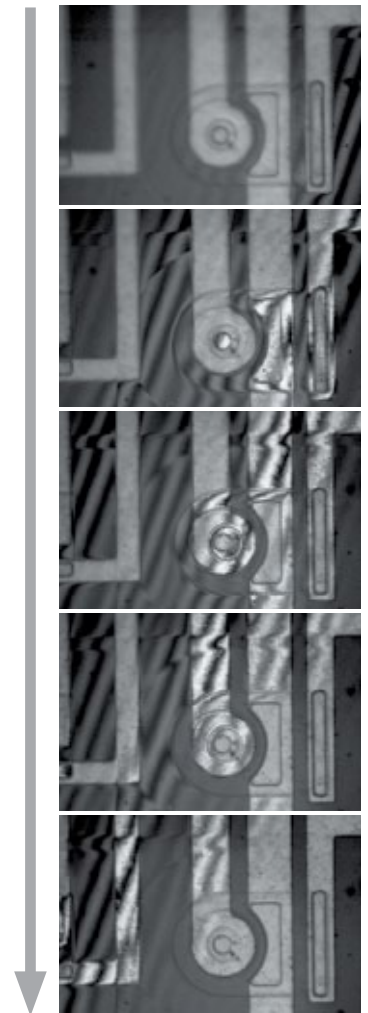

Steps of an interferometric scan of a wafer surface

SIMPLE IMAGE CAPTURE WITH BRIGHTFIELD AND DARKFIELD MICROSCOPY

Alongside confocal and interferometric topography analysis, the Leica DCM8 also offers both brightfield and darkfield imaging for simple image capture in either color or black and white. Brightfield gives you a quick overall impression of a material surface and the actual position onto the sample in true color. Darkfield can be useful for samples where surface details such as scratches or particles may be difficult to distinguish with brightfield illumination.

Ceramic surface

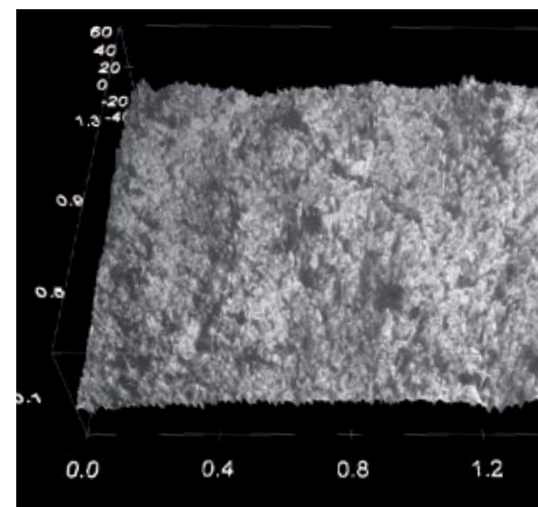

FOUR LEDs FOR RGB HD IMAGING AND WIDER APPLICATION RANGE

The Leica DCM8 includes four LEDs, blue (460 nm), green (530 nm), red (630 nm) and white (centered 550 nm). By increasing the number of colors and therefore wavelengths available, the application range is extended. For example, if you are working with semiconductor wafers and photoresist where the sample is sensitive to blue light, you can choose to use only red light for image capture.

You'll have an ultra-sharp full color image at hand

The RGB LEDs in combination with the HD CDD camera also enable the Leica DCM8 to produce an ultra-sharp full color image equivalent to a 5 Megapixel camera. By pulsing the LEDs sequentially the system records the true color information in each pixel. There is no need for color interpolation, something very common when

using standard color cameras with Bayern filters. Image resolution and contrast are therefore increased for crystal-clear, true-to-life visualization of your sample. The white LED also allows you to work with improved White Light Interferometry. Last but not least, the LEDs have a very long average lifetime of approximately 20,000 hours.

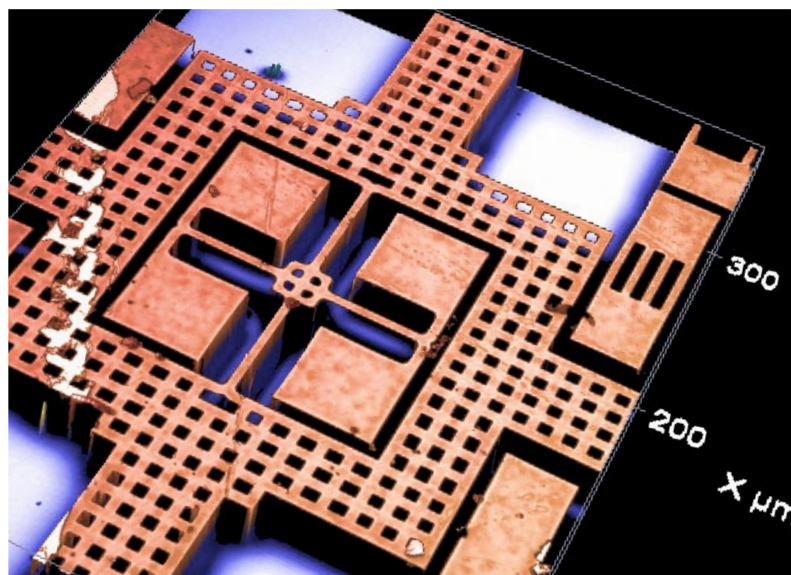
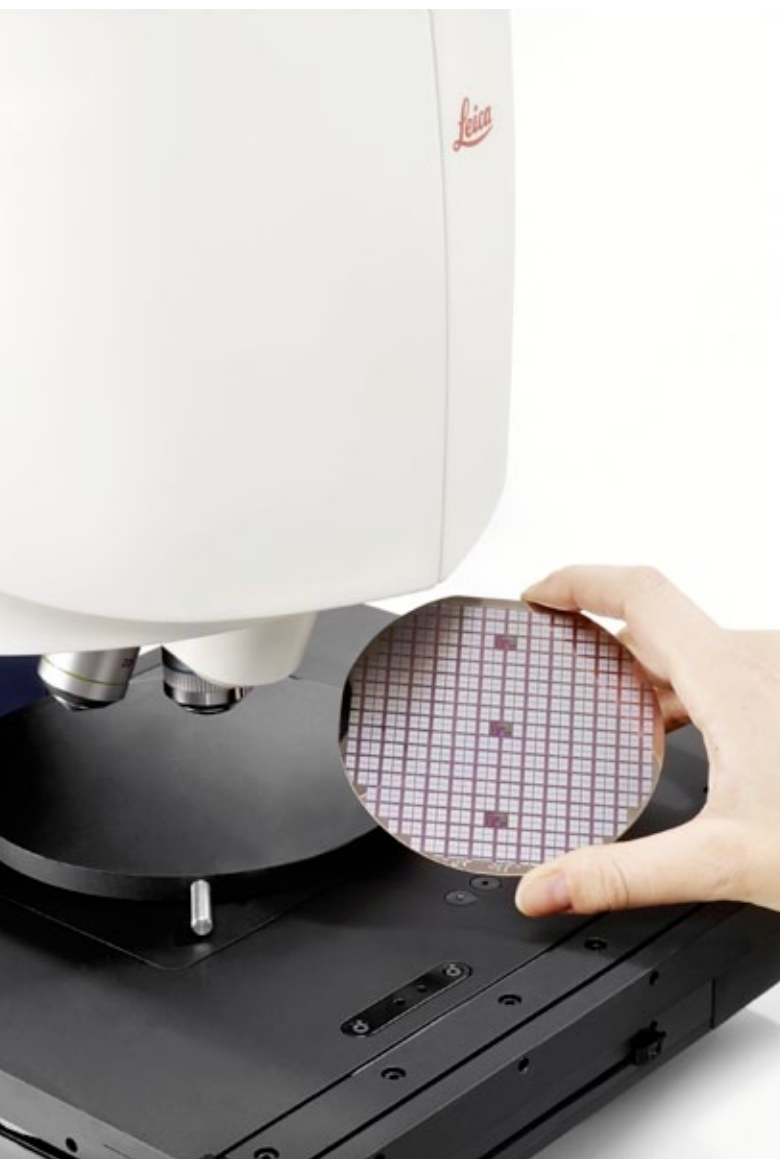



Graphical representation of internal elements

THREE METHODS FOR MEASURING THICK AND THIN FILMS

The Leica DCM8 offers three alternative techniques for thickness measurements: confocal mode, interferometry mode and spectroscopic reflectometer mode. The confocal and interferometry techniques can be used to measure the thickness of a transparent layer or foil, as well as the surface of the layer substrate or layer-air interface. Options for thickness measurements include single point, profile, and topography. The optional spectroscopic reflectometer is very effective for single and multiple foils, membranes or thin layers on a substrate, and can also deal with more sophisticated structures (up to ten layers on a substrate). Transparent films from 10 nm to 20 μm can be measured effectively with this technique.

THE RIGHT CONFIGURATION AND OBJECTIVE FOR YOUR SAMPLE

You'll have optics of breathtaking quality

The Leica DCM8 employs our world-renowned objectives for confocal, brightfield and darkfield, from 1.25x to 150x magnification with a wide range of working distances to meet your specific requirements. If you need to analyze your samples with the highest lateral resolution, immersion objectives with high numerical apertures are available. For analysis of a surface below a transparent layer, our purpose-designed objectives with a correction collar allow focusing through layers.

In addition, a full range of Multiple Reflectivity (MR) interferometry objectives is available at 5x, 10x, 20x and 50x magnification. These state-of-the-art MR objectives:

- Match the reflectivity of the sample, allowing the system to get the optimum contrast of the interference fringes for the best possible surface characterization of all kinds of samples
- Have an easy compensation system for thermal drifts should they occur

We offer you optics for every task

The optics experts at Leica Microsystems have also developed MR low magnification objectives that can be used for both confocal and interferometry, maximizing value for money and further increasing the flexibility of the system. If you have a repetitive task to perform where you require the highest accuracy, we can also offer you our Single Reflectivity (SR) objectives that have been optimized to deliver the best metrological and imaging performance.

You can configure to your needs

Our range of motorized stages and columns facilitates working with large samples and renders sample preparation or manual adjustment unnecessary. The Leica DCM8 can be configured with motorized stages of up to 300 x 300 mm including XYZ joystick control, as well as Z columns up to a height of 1 m. Any other requirements? Contact us to discuss a custom configuration.

The streamlined design and the use of microdisplay scanning technology without moving parts in the sensor head enable the Leica DCM8 to be easily integrated into other systems for process control applications. For the highest stability and accuracy of results the Leica DCM8 can be mounted on a bench top or floor-standing anti-vibration table according to available space. It is even possible to employ the unit upside down if required.



“We decided to buy the Leica DCM system due to its ability to operate as an optical microscope with brightfield, darkfield and confocal, as well as three interferometric modes. Flexibility is the most important factor for a diversified institute working in materials science such as ours.” Christof Scherrer, IMPE, Winterthur, Switzerland

The rotating objective nosepiece

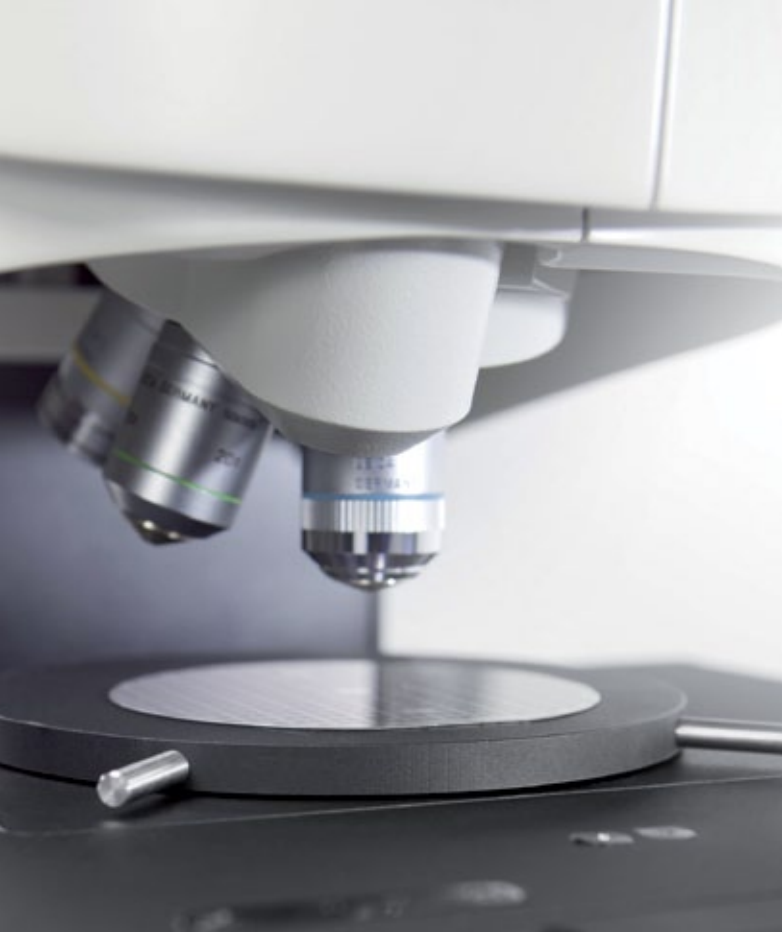

An example of an interferometry objective

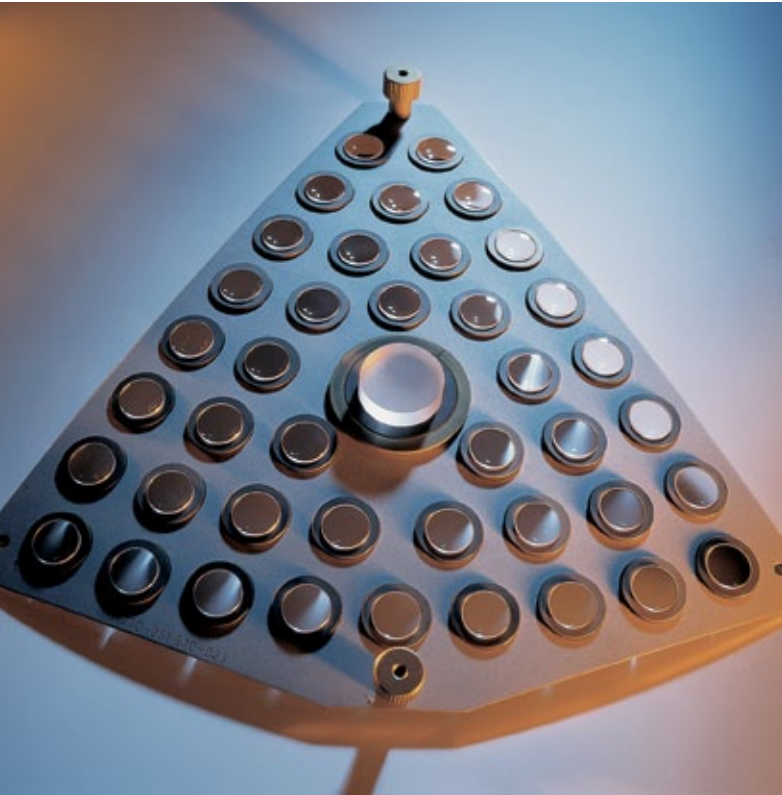
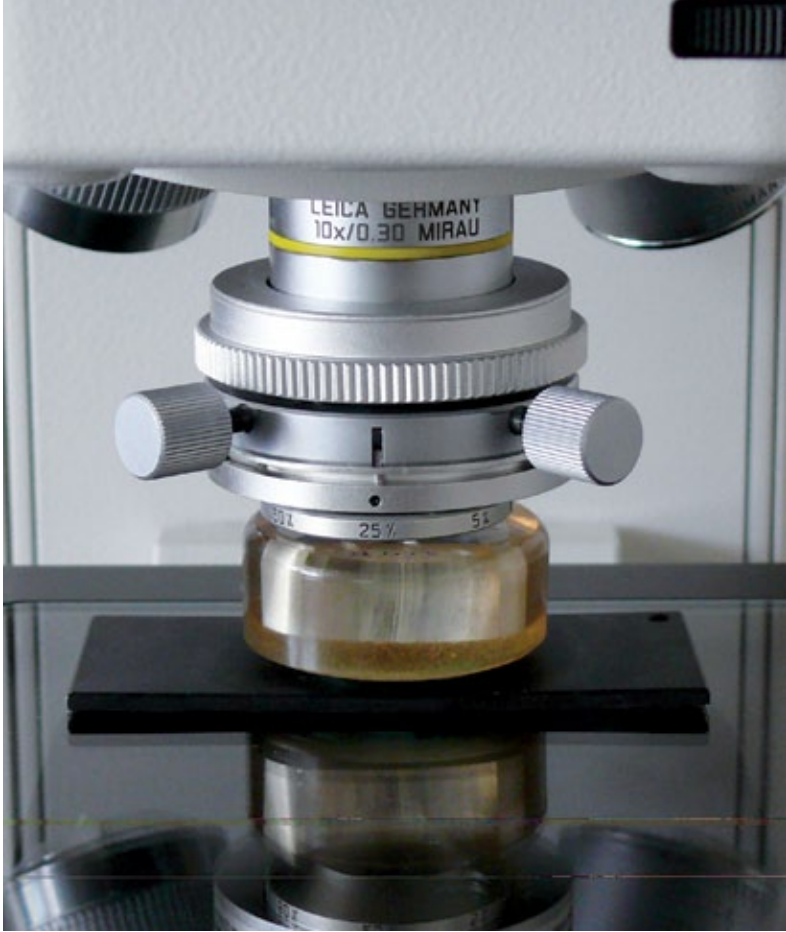

A selection of hand-polished lenses which form the core of our objectives

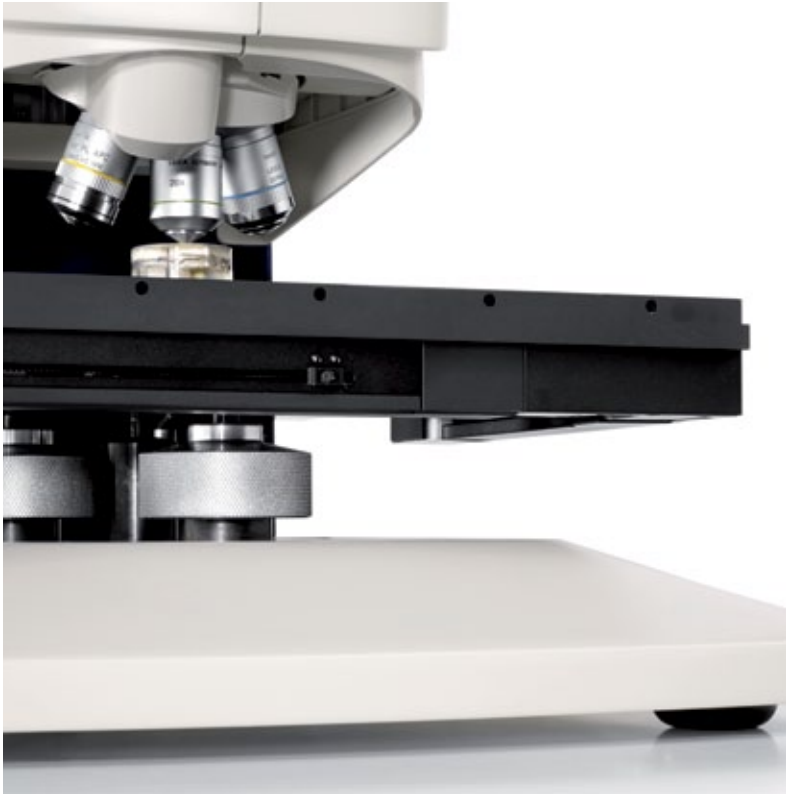

A range of manual and motorized stages are available to suit your sample

Fast, Simple and Durable – Less Time, Money and Effort for Maximum Results

The need for reliable, precise surface characterization in any application is a prerequisite, but in manufacturing, speed is also vital in order to avoid costly interruptions in production processes. The Leica DCM8 is easy to operate and fast at acquiring surface data and images. The intuitive software also makes further analysis simple and the durable design ensures a long lifespan with minimal cost of ownership.

NO NEED TO PREPARE SAMPLES OR SWAP INSTRUMENTS

By uniting confocal microscopy and interferometry with the additional possibilities of brightfield and dark-field imaging, there is no need to waste time swapping between instruments for different analyses – the

ideal method is just a click away! In addition, unlike some surface characterization methods, most samples can be accurately profiled without sample preparation or destruction, as scanning is contact free. Different sample

sizes can be easily accommodated by choosing the objective with the most appropriate working distance from our comprehensive objective portfolio, in combination with the right size stage and column.

FAST, RELIABLE DIGITAL HD CONFOCAL SCANNING

The Leica DCM8 features vibration-free scanning with highly reproducible results thanks to the advanced HD microdisplay technology based on ferroelectric liquid crystal on silicon (FLCoS). This innovative technology features a fast switching device inside the sensor head with no moving

parts. This design ensures extremely stable results, noise reduction and impressive metrological performance in terms of accuracy and repeatability. Not only is acquisition extremely quick, but so is the live confocal, up to 12.5 confocal frames per second, allowing you to work directly on the

live image for even greater efficiency. In addition, the lack of moving parts in the sensor head significantly increases durability of the instrument for virtually maintenance free operation over an extended lifetime of usage.

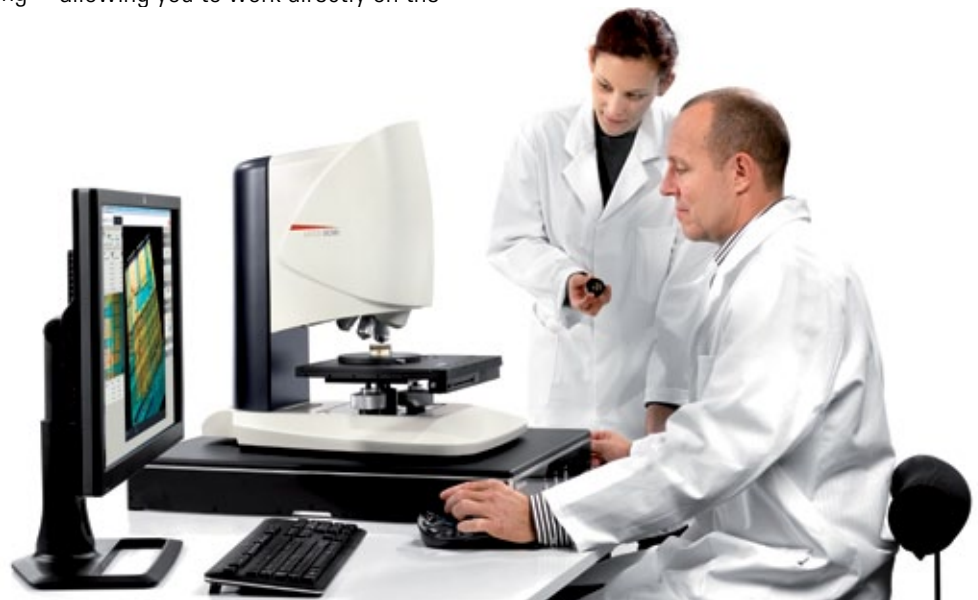

CAPTURE LARGE SURFACES QUICKLY WITH LARGE FOV AND TOPOGRAPHY STITCHING

Thanks to the integrated high-resolution CCD camera, the Leica DCM8 has a very large Field of View (FOV). As a result, more of the sample surface can be captured at once, helping you to optimize your workflow efficiency.

You can see it all

In the quality control of industrial components high resolution measurement of a smaller section of the sample is often required as well as a fast scan of a larger area. To meet this requirement, the Leica DCM8 offers ultra-fast

XY topography stitching. In this mode, acquired 3D models are automatically joined together to form a topographic image far larger than a single FOV. The final surface data shows a seamless, highly precise model of a large surface area including perfectly in focus texture, while keeping the original optical properties of the smaller section. Different stitching algorithms are easily applied depending on the surface geometry of the sample, from completely flat to curved topographies.

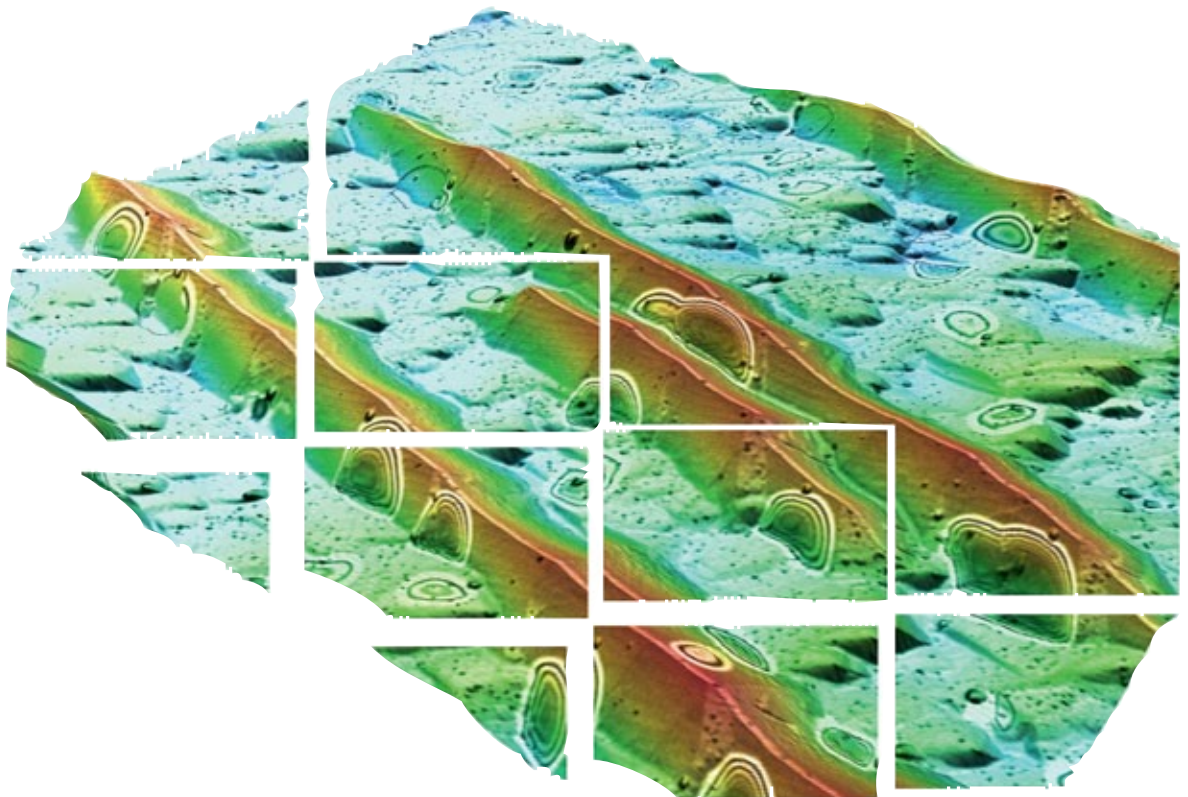

“From my point of view, the two main strong points of the Leica DCM8 are the fast image and data acquisition and the high resolution camera. Fast data acquisition is key because we are usually interested in measuring a very big surface so stitching is mandatory.” Dr. Jordi Diaz, CCiT, University of Barcelona, Spain

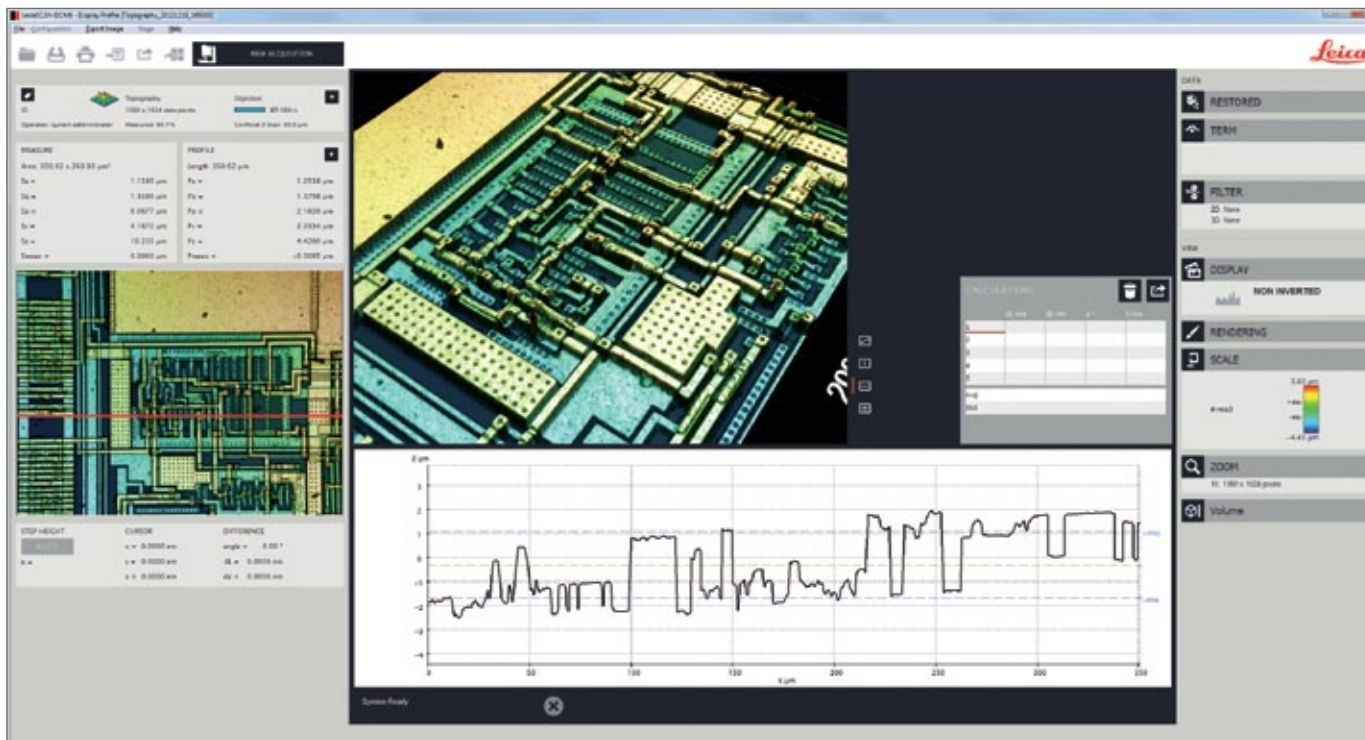

1

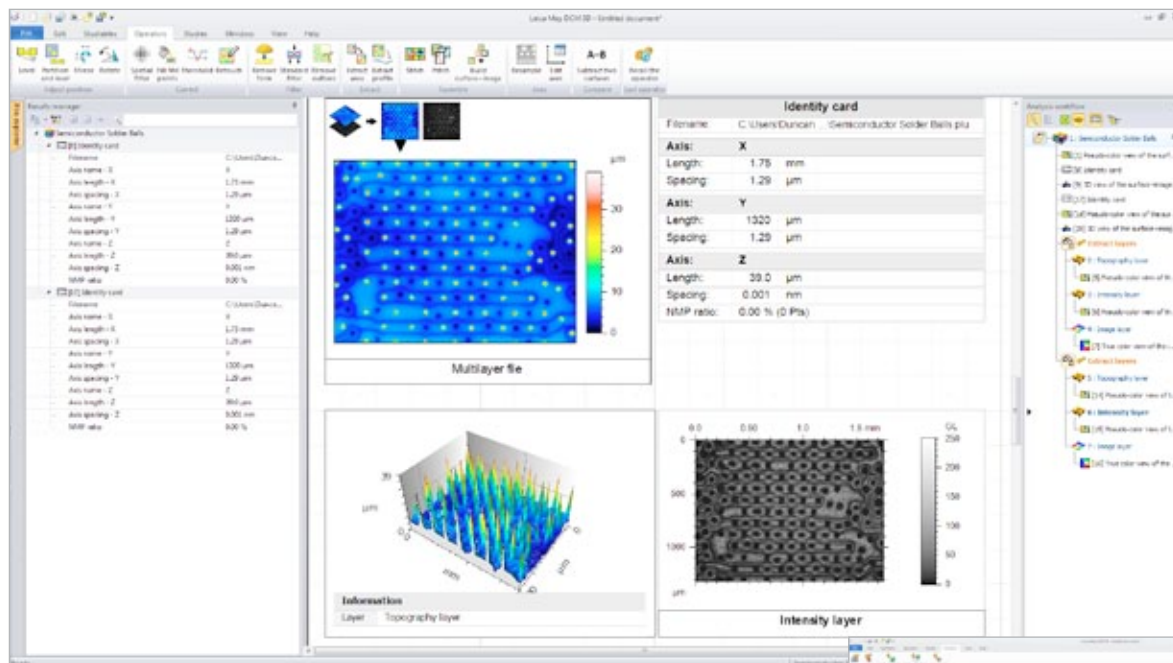

2

- 1. LeicaSCAN software
- 2. & 3. LeicaMap software

3

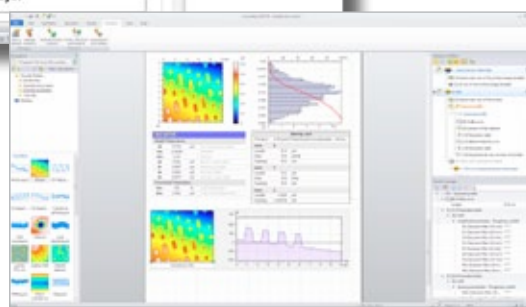

FAST AND INTUITIVE SOFTWARE FOR DATA ACQUISITION AND ANALYSIS

The Leica DCM8 is controlled by LeicaSCAN software. This powerful software has an icon-based interface for fast, intuitive data capture and analysis. When large numbers of measurements need to be taken, LeicaSCAN offers several pre-defined recipe programs enabling one-button operation. Additionally, the Multiple Measurement Recipe (MMR) can be used to acquire measurements from different XY locations, repeat measurements in the same position, assess evolution and then obtain statistical information quickly and accurately.

We make sophisticated 3D analysis simple

Our optional LeicaMap software delivers a comprehensive set of surface parameters and 3D transformations for advanced 3D analysis. These include: step height and bearing ratio, areal surface texture parameters (ISO 25178, EUR 15178), primary and roughness parameters on cross-sectional profiles (ISO 4287), fourier analysis, fractal analysis and much more. LeicaMap is particularly useful in R&D departments and laboratories for off-line surface characterization, or in production for near-line control.

You can quickly analyze in 2D

As well as capturing and measuring 3D data in your daily work, detailed 2D analysis is often required. To meet this need, our popular Leica Application Suite (LAS) software is also available for the Leica DCM8. LAS expands the 2D analysis capabilities of the system from simple area measurements to complex and automated geometrical analysis.

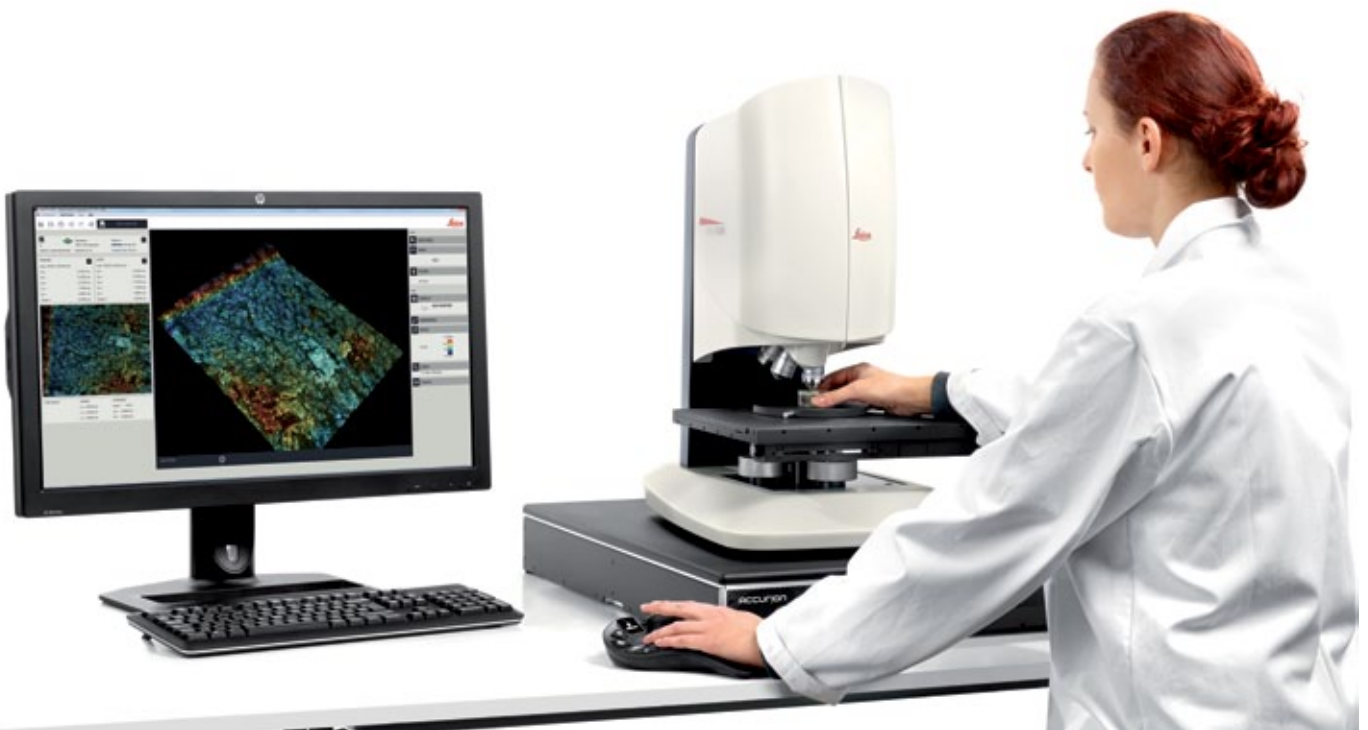

General Specifications

Measuring Principle	Dual Core Optical Imaging Profilometry (Confocal and Interferometry) non-contact, 3D
Capabilities	HD Imaging, HD 3D Topography, Profiles, Coordinates, Thickness, Roughness, Volume, Surface Texture, Spectral Analysis, Color Analysis, etc.
Contrast modes	HD Confocal, HD Interferometry (PSI, ePSI, VSI), HD Brightfield Color, Brightfield, Darkfield, Real Time HD RGB Confocal
Sample height	40 mm standard; up to 150 mm with adjustable column; larger sample height possible on request
Objectives	From 1.25× up to 150× in confocal, brightfield and darkfield mode; from 5× up to 50× in interferometry mode
Nosepiece	6-fold objective revolver manual / 6-fold objective revolver motorized
Stage scan range (x,y,z)	Vertical: z = 40 mm; lateral: xy = standard 100 x 75 mm or up to 300 x 300 mm. Larger stages possible on request
Vertical scan range	Confocal 40 mm, PSI 20 μm, ePSI 100 μm, VSI 10 μm
Illumination	LED light sources: red (630 nm), green (530 nm), blue (460 nm) and white
Image Acquisition	CCD B&W Sensor: 1360 x 1024 pixels (full resolution); B&W 35 FPS True Color / Confocal: 3 FPS (full resolution), 10 FPS (half resolution), 15 FPS Live Confocal
Sample Reflectivity	0.1% - 100%
Dimensions & weight	L x W x H = 573 mm x 390 mm x 569 mm; weight: 48 kg
Operating conditions	Temperature: 10° to 35° C; Relative Humidity (RH) < 80%; RH altitude < 2000 m
Vibration Isolation	Active or passive
Repeatability (50 x magnification)	Confocal / VSI: error = 0.003 μm (3 nm); PSI: error = 0.16 nm (0.00016 μm)
Accuracy (20 x magnification)	With open loop: < 3% relative error; with closed loop: < 20 nm error

Confocal Mode

Objective Magnification	1.25×	2.5×	5×	10×	20×	50×	100×	150×
Numerical Aperture	0.04	0.07	0.15	0.3	0.5	0.9	0.95	0.95
Field of View (μm)	14032 x 10560	7016 x 5280	3508 x 2640	1754 x 1320	877 x 660	351 x 264	175 x 132	117 x 88
Optical Resolution (X/Y) (μm)	3.5	2.0	0.94	0.47	0.28	0.16	0.14	0.14
Vertical Resolution (nm)	<3000	<350	<150	<30	<15	<5	<2	<2
Typical Measurement Time	3 – 5 seconds							

Interferometry Mode

Objective Magnification	5×	10×	20×	50×
Numerical Aperture	0.15	0.30	0.40	0.50
FOV (μm)	3508 x 2640	1754 x 1320	677 x 660	351 x 264
Optical Resolution Blue (x/y) (μm)	0.94	0.47	0.35	0.28
Optical Resolution White (x/y) (μm)	1.12	0.56	0.42	0.33
Vertical Resolution (nm)	PSI <0.1; ePSI < 1.0; VSI < 3.0			
Vertical Scanning Speed (μm/s)	VSI / ePSI: 2.4 – 17 μm/s			
Typical Measurement Time	PSI: 3 – 6 secs; VSI: 10secs; ePSI: 30 secs			

Dimensional Drawings / Configurations

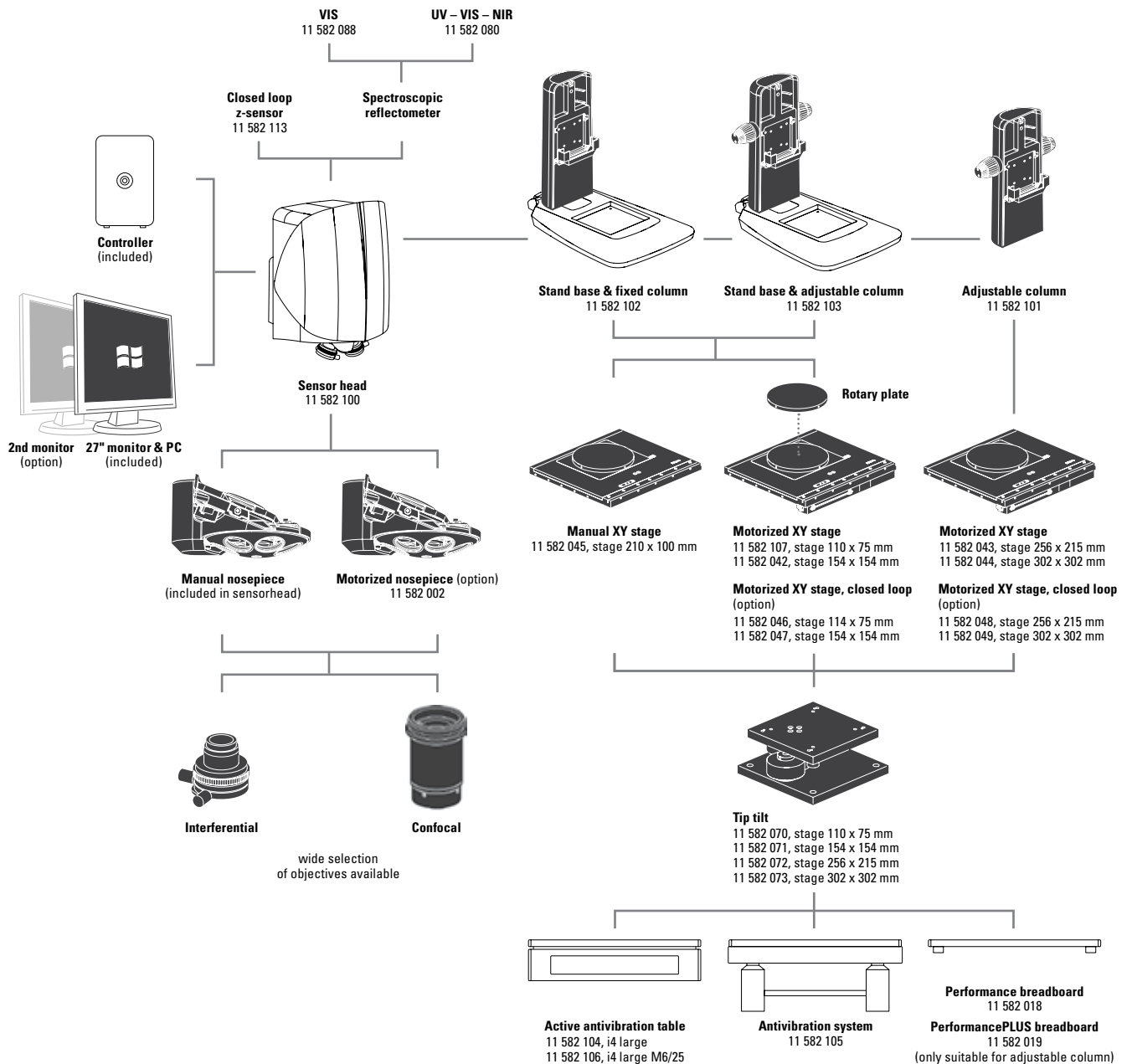
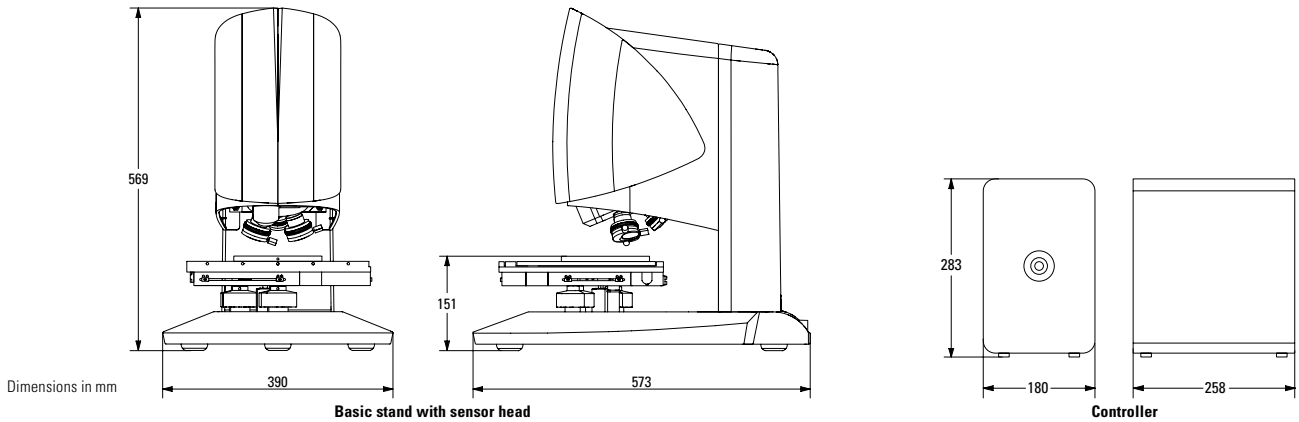

The statement by Ernst Leitz in 1907, “*With the User, For the User,*” describes the fruitful collaboration with end users and driving force of innovation at Leica Microsystems. We have developed five brand values to live up to this tradition: Pioneering, High-end Quality, Team Spirit, Dedication to Science, and Continuous Improvement. For us, living up to these values means: **Living up to Life.**

Leica Microsystems operates globally in three divisions, where we rank with the market leaders.

LIFE SCIENCE DIVISION

The Leica Microsystems Life Science Division supports the imaging needs of the scientific community with advanced innovation and technical expertise for the visualization, measurement, and analysis of microstructures. Our strong focus on understanding scientific applications puts Leica Microsystems’ customers at the leading edge of science.

INDUSTRY DIVISION

The Leica Microsystems Industry Division’s focus is to support customers’ pursuit of the highest quality end result. Leica Microsystems provide the best and most innovative imaging systems to see, measure, and analyze the microstructures in routine and research industrial applications, materials science, quality control, forensic science investigation, and educational applications.

MEDICAL DIVISION

The Leica Microsystems Medical Division’s focus is to partner with and support surgeons and their care of patients with the highest-quality, most innovative surgical microscope technology today and into the future.

Leica Microsystems – an international company with a strong network of worldwide customer services:

Active worldwide		Tel.	Fax
Australia · North Ryde	+61	2 8870 3500	2 9878 1055
Austria · Vienna	+43	1 486 80 50 0	1 486 80 50 30
Belgium · Diegem	+32	2 790 98 50	2 790 98 68
Canada · Concord/Ontario	+1	800 248 0123	847 405 0164
Denmark · Ballerup	+45	4454 0101	4454 0111
France · Nanterre Cedex	+33	811 000 664	1 56 05 23 23
Germany · Wetzlar	+49	64 41 29 40 00	64 41 29 41 55
Italy · Milan	+39	02 574 861	02 574 03392
Japan · Tokyo	+81	3 5421 2800	3 5421 2896
Korea · Seoul	+82	2 514 65 43	2 514 65 48
Netherlands · Rijswijk	+31	70 4132 100	70 4132 109
People’s Rep. of China · Hong Kong	+852	2564 6699	2564 4163
· Shanghai	+86	21 6387 6606	21 6387 6698
Portugal · Lisbon	+351	21 388 9112	21 385 4668
Singapore	+65	6779 7823	6773 0628
Spain · Barcelona	+34	93 494 95 30	93 494 95 32
Sweden · Kista	+46	8 625 45 45	8 625 45 10
Switzerland · Heerbrugg	+41	71 726 34 34	71 726 34 44
United Kingdom · Milton Keynes	+44	800 298 2344	1908 246312
USA · Buffalo Grove/Illinois	+1	800 248 0123	847 405 0164



www.leica-microsystems.com/dmc8

