

# HARDNESS TESTING

# DUROLINE

# M SERIES





 **VICKERS**  
50 YEARS OF  
EXPERIENCE

DUROLINE-M

# VICKERS & KNOOP

FULLY AUTOMATIC HARDNESS TESTING

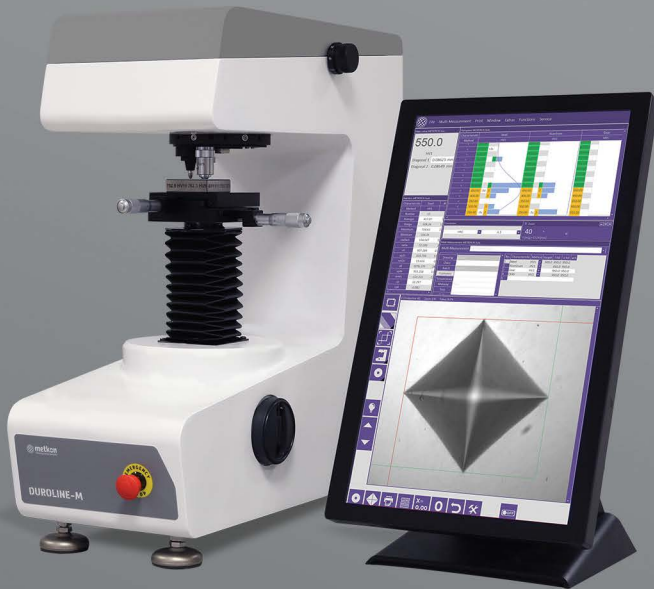

# DUROLINE M1/M2/M3/M4

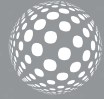

Smart hardness testing with smashing performance  
- NEW GENERATION -

## Main system features

- Complete micro-load range for HV/HK scales from 10gf to 1kgf
- Auto Measurement with Zoom Window for more accurate measurement
- Flexible Windows 10 based hardness test & measurement program METKON N-Sure
- Database generating test results and reports
- 22" Full HD Capacitive 10-point Multi-Touch desktop monitor
- Integrated high-res camera 420MB/s with USB3.1 interface with zoom capability
- Integrated LED light source with controller
- Integrated Windows operated mini-pc, Intel, SSD specs
- Interface network USB (4), RS-232 (1), HDMI (1)
- Very robust opto-mechanical system
- New generation electronics and motors in full system integration ensuring reliable performance
- Service friendly, remote accessibility
- Meets latest ISO, ASTM and JIS standards

## DESIGN

DUROLINE M Series are ideal instruments for quality assurance, quality control, research and metallurgical departments to monitor the hardness during fabrication and after heat treatment or welding as well as for the performance analysis on metal parts and new alloys. Typical applications are determining the Vickers microhardness of small precision parts, thin material or wire, coatings and performing case depth determinations (CHD, EHT, NHT) on cross sections, both manually or automatic on this advanced hardness tester system.

Recently developed by an international multi-disciplinary team with a wide hardness testing experience, the DUROLINE M-Series are based on the latest technology available, focused on fast cycle time with high reproduceable accuracy within international standards. The system features a smart and very service-friendly synergy of a robust and proven mechanical construction and integrated electronics system control featured by a fast CANBUS technology and a high-quality Windows based mini-pc. Monitoring the hardness testing process significantly improved by using modern user interfacing technology such as 10-point multi-touch screen operation supported by a fast & secure display connection. Combined with top quality components and a high performance mini-pc, this system guarantees customers a solid and accurate performance over many years to come. In this way, the DUROLINE M Micro-Vickers hardness tester offers a highly functional and reliable automated indentation test & measurement system.

### Complete micro-load range for HV/HK scales from 10gf to 1kgf

By selecting between 8 loads steps for microhardness testing in Vickers or Knoop, any specimen can be tested and measured within the applicable standards. Fast and easy setting of loads by a conventional manual knob.

### Magnification range

Combining the excellent performance of the digital camera, LED illumination and software with a series of available objectives, the DUROLINE M Series provide correct measurement under any test load within the international standards .



DUROLINE M-Series Microhardness Tester



Robust Mechanical Design



22" Full HD Capacitive 10-point Multi-Touch desktop monitor

### High precision spindle with motorized option

For accurate microhardness testing and fast auto-focusing, the elevating speed and backlash of the spindle are critical. By using quality components and design experience, the DUROLINE M Series spindles guarantee long life without loss of accuracy due to wear and friction, even for automated Z-axis systems.

## AUTOMATIC TEST & MEASUREMENT



The METKON *N-Sure* software program features a flexible Windows based user interface that increases productivity and operator efficiency by automating the test & measurement process and optional motor-stage navigation process. Since the application and removal of the test loads and measurement are fully automatic, repeatability is excellent, testing time is reduced and throughput is increased. As a result, costly and time-consuming rework is eliminated.

For high-volume mounted sample testing, multi-sample mount holders are available for automated test applications to further increase the productivity and throughput of samples.

The easy-to-operate test & measurement program, clear images captured by integrated camera and high-resolution display on 22" touch screen monitor provide the lab staff easy access and shared visibility of indent results to analyze and discuss together. Operators are guided by the user-friendly program logic combined with quick manual system settings such as fast weight setting by the conventional manual knob. Vickers or Knoop hardness values are automatically generated on screen by use of the standard provided Auto-measurement function.

### Database generating test results and reports

METKON *N-Sure* software program provides advanced database management of test results, report generation and printing functions. Saving and retrieving measurement data is an absolute requirement when it comes to testing hardness results of critical components in various industrial segments. The *N-Sure* program ensures that data is safely stored and presented in standard or customized reporting form.



22" Full HD Capacitive 10-point Multi-Touch desktop monitor



METKON *N-Sure* Advanced User Interface Software

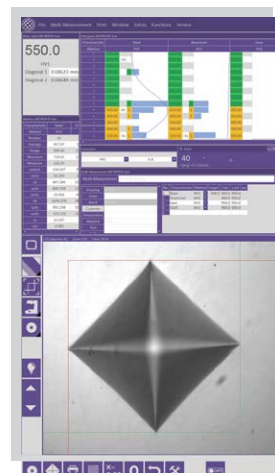

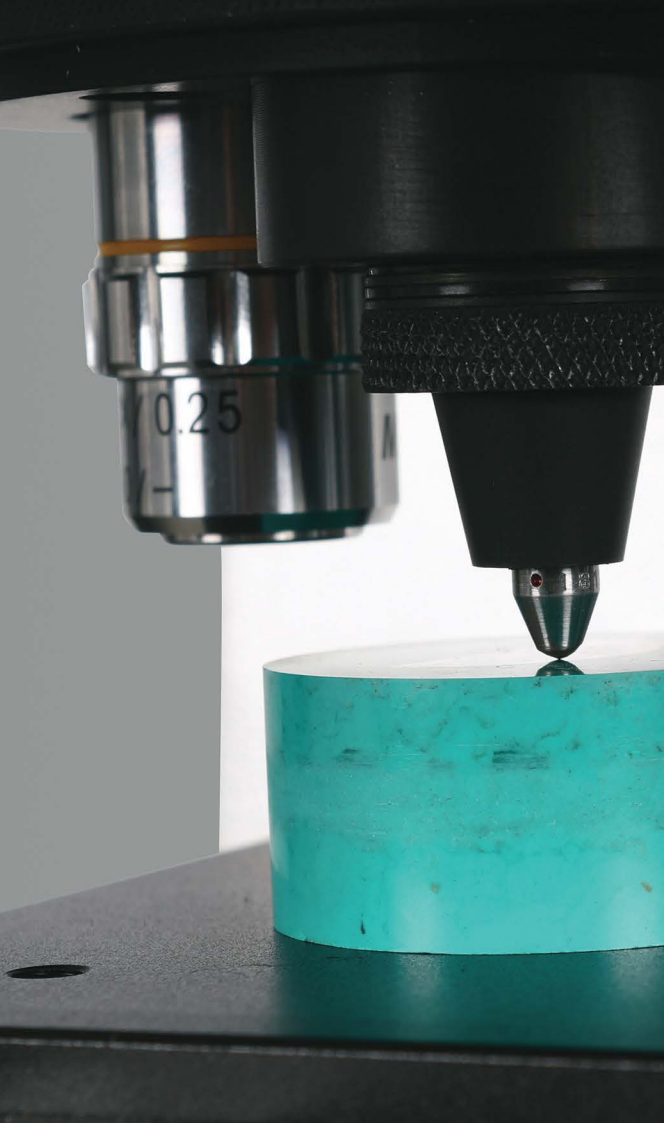

**Comes with ISO/DaKKS Certified Vickers Indenter (Made in Germany)**

An ISO/DaKKS Certified Vickers Diamond Indenter is included as standard for all DUROLINE M-Series Hardness Testers.

**Factory Certificated Direct and Indirect Calibration Report**

All DUROLINE M-Series testers are calibrated in Metkon Factory according to DIN EN ISO 6507-2:2018 Vickers hardness test standard.



# GENERAL FEATURES HIGHLIGHT

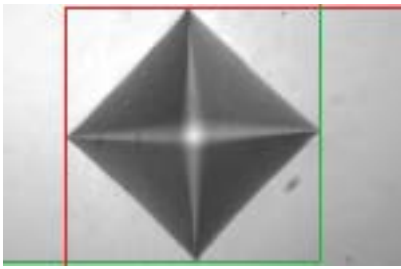

## Automatic Test & Measurement

The measurement program provided as standard the Auto-measurement function for fast and repeatable results. This provides extra convenience and time saving. Manual measurement is always possible, as well as re-measurement or deleting single hardness values.



## N-Sure Advanced User Interface Software

The METKON N-Sure software program features a flexible Windows based user interface that increases productivity and operator efficiency by automating the test & measurement process. The User Interface has an immediate recognition and provides a user-friendly flexibility in settings and daily operation.



## 22" Full HD Multi-Touch Desktop Monitor

The easy-to-operate test & measurement program, clear images capture by integrated camera and high-resolution display on 22" touch screen monitor provide the lab staff easy access and shared visibility of indent results to analyze and discuss together.



## Integrated Windows Operated Mini-PC

A Windows operated industrial mini-pc is hidden inside the hardness tester. Thus, no additional space is required for your laboratory. It is capable to work 24/7 thanks to its compact, robust design. Equipped with powerful Intel processor and SSD drive to provide smooth and fast operation.



## Integrated High Resolution CCD Camera

A high resolution CCD camera is hidden inside the hardness tester. It has 5.0 MP resolution which provides to capture very clear indentation image for accurate auto measurement. It has USB 3.0 interface to monitor without any delay. This means; when you move the specimen that under the objective, the image on the monitor also moves very smoothly and quickly at the same time.

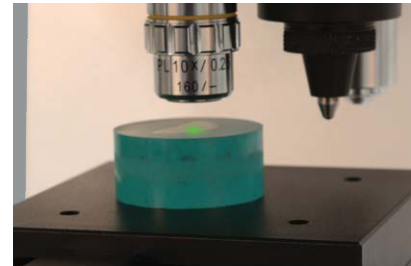

## Automatic Light Brightness

The light brightness is automatically adjusted by the user interface software for the best image quality and the most accurate auto measurements. The hardness tester equipped with powerful LED light source and compact optic system to provide excellent image quality.



## Automatic Focus

[Available on M2 and M4 models]  
DUROLINE M2 and M4 models are equipped with high precision motorized spindle and Autofocus software module. It automatically sharpens the image in seconds. This provides extra convenience, maximum automation and time saving.

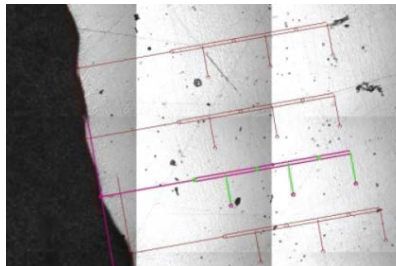

## Motorized XY-Stage

[Available on M3 and M4 models]  
DUROLINE M3 and M4 models are equipped with high precision motorized XY-stage with 100x150 mm travel range and Autostage software module. It provides multiple tests & measurements fully automatically without operator intervention. Mapping function allows overview image of complete sample surface. The test points are easily determined on the sample with pre-defined or user defined patterns.

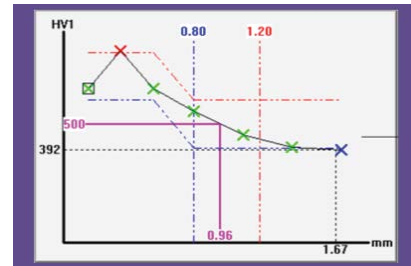

## EHT - CHD Testing

XY-stage with one Slyvac digital micrometer and software module for EHT-CHD testing are optionally available for all DUROLINE M-Series. Possibility to direct reading of Slyvac micrometer signals by N-Sure software and generate case hardening depth graph.

## ACCESSORIES

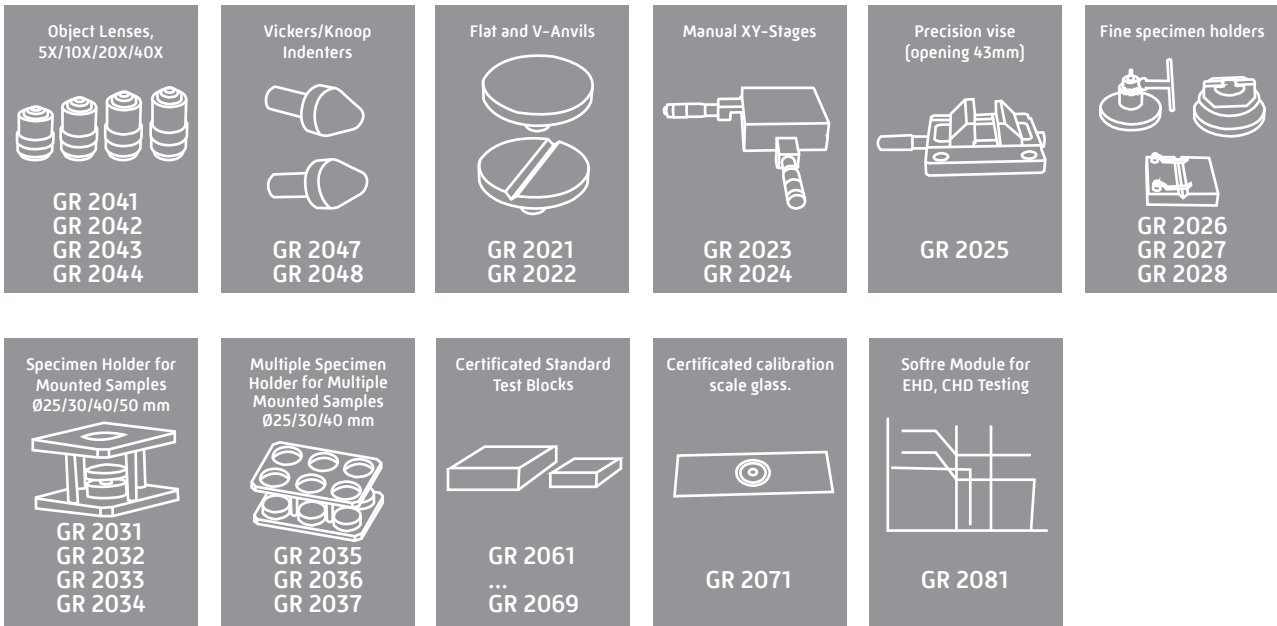

### Test stages

The DUROLINE M Series feature various stages and fixtures that fit any application. Starting with the basic manual XY-stage with either mechanical or digital micrometers, the hardness tester can also be equipped with a motorized stage to facilitate single or multi-sample holders. To fix various geometries of specimen that are not mounted, there are several clamping devices available to finish the job quick and precise.



High Precision Manual XY Stages



High Precision Test Anvils

### Object Lenses

DUROLINE M equipped with 10x and 40x high quality German made object lenses for maximum image sharpness. 5x and 20x objectives are also optionally available for all kind of testing needs.

### Test Blocks

ISO/DaKKS certificated German made test blocks are optionally available for Indirect verification of tester.

### Indenters

ISO/DaKKS certificated German made Vickers and Knoop indenters are optionally available for most accurate and reliable testing.



High Precision Sample Holders

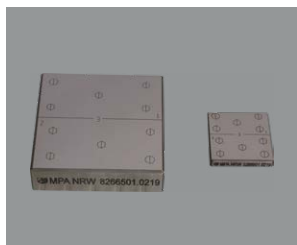

ISO/DaKKS Certificated Test Blocks



ISO/DaKKS Certificated Vickers and Knoop Indenters



High Quality Object Lenses with 5X, 10x, 20x and 40x Magnification

# SPECIFICATIONS

ORDER NO	72 01		72 02		72 03		72 04	
MODEL NO	M1		M2		M3		M4	
Hardness Scales	Vickers HV as per ISO 6507, ASTM E384, E92				HV0,01 - HV0,025 - HV0,05 - HV0,1 - HV0,2 - HV0,3 - HV0,5 - HV1			
	Knoop HK as per ISO 4545, ASTM E384, E92				HK0,01 - HK0,025 - HK0,05 - HK0,1 - HK0,2 - HK0,3 - HK0,5 - HK1			
	Hardness conversions to other scales				As per ISO 18265			
Test Loads	Test Loads [gf]		10gf - 25gf - 50gf - 100gf - 200gf - 300gf - 500gf - 1000gf					
	Test Loads [N]		0,09807N - 0,2452N - 0,4904N - 0,9807N - 1,961N - 2,942N - 4,904N - 9,807N					
	Test Load Accuracy		*10gf - 200gf: +/- 1,5% and > 200gf: +/- 1,0% As per ISO standard (and ASTM E-384, JIS B7725, JIS B7734)"					
	Test Load Dwell Time		*from 5 - 99 sec with 1 sec increments As per ISO standard (and ASTM E-384, JIS B7725, JIS B7734)"					
	Test Load Application Speed		*10gf - 200gf: < 0.070 mm/s and > 200gf: < 0.200 mm/s As per ISO standard (and ASTM E-384, JIS B7725, JIS B7734)"					
	Load Force Application		Dead-weight, Automatic motorized, load, dwell, unload					
	Load Selection		Manual by external setting knob					
Turret	Turret Configuration				Motorized 3-mount turret: 1 indenter, 2 objectives Position Auto-indication			
	Indenter				Including 1 Vickers Diamond Indenter (ISO/DaKKS certified, Made in Germany)			
	Objectives				*Standard objectives 10X, 40X, optional 5X, 20X (Made in Germany) Image capture by integrated CCD-camera (no eyepiece)"			
Optic System	Sample Image Capture				By Integrated CCD Camera, 5.0 MP, USB 3.0 (Made in Germany)			
	Indent Measurement Resolution				0,00002 mm (0,02 µm)			
Illumination	Illumination Source				Built-in LED Light Source			
	Automatic Brightness Control				Standard for highest contrast and sharpnes			
Spindle	Z-axis (Spindle Vertical Movement)		Manual	Motorized	Manual	Motorized		
	Auto-Focus AF		Not Available	Standard	Not Available	Standard		
"Motorized XY-Stage"	Motorized XY-Stage (for Fully Automatic Multiple Test & Measurements)		Not Available	Not Available	Standard	Standard		
	Travel Distance		Not Available	Not Available	100x150 mm	100x150 mm		
Controller System	Controller				*Built-in Windows operated mini-PC, communicates the hardness tester electronics by CANBUS Protocol"			
	Interface Network				4xUSB, 1xRS-232, 1xHDMI			
	Auxilliary				Optional Keyboard, Mouse (wireless)			
	Monitor				*External 22" Full HD Capacitive 10-point Multi-Touch Desktop Monitor, IPS Panel, Antistatic Shield, Tilttable, Integrated Power Adaptor"			
User Interface	Operating System				Windows 10			
	User Interface Software				METKON N-Sure			
	Test Settings				Scale, Load Dwell Time, Start, Turret positioning, Hardness Conversion, Illumination, Screen preference settings, Alerts for errors			
	Measurement Settings				Surface Image capture, Indentation capture, Manual measurement and Auto-measurement, Single indents, Manual pattern, Preset pattern, CHD, EHT, NHT, GO/NG judgement, Statistics, Conversion, Cylindrical correction, Language, Database, Test Reports with image analysis data, Data export, User management, Service and Calibration Settings			
Tester Body	Operational Environmental Conditions				*Ambient Operating Temperature Range: 23°C +/- 5°C Ambient Humidity Range: RH 40% to 70% relative humidity, non-condensing"			
	Dimensions, WxDxH				240x560x625 mm			
	Specimen Accomodation				Vertical 185 mm, Horizontal (throat depth) 160mm			
	Weight				65 kgs			
	Mains				100-240 V, 1-phase, 50/60 Hz, autoseeting			

ORDER NO	Automatic Test & Measurement	Automatic Light Brightness Control	Motorized Z-Axis Spindle	Automatic Focus	Motorized XY-Stage
DUROLINE M1	✓	✓	✗	✗	✗
DUROLINE M2	✓	✓	✓	✓	✗
DUROLINE M3	✓	✓	✗	✗	✓
DUROLINE M4	✓	✓	✓	✓	✓



# SPECIFICATIONS

72 01

## — DUROLINE M1

Vickers/Knoop Micro-Hardness Tester with Test & Measurement software Windows 10 "N-Sure" including Auto-Measurement module Test Loads: 10, 25, 50, 100, 200, 300, 500, 1000 gf suitable for testing HV0,01 - HV0,025 - HV0,05 - HV0,1- HV0,2 - HV0,3 - HV0,5 - HV1 HK0,01 - HK0,025 - HK0,05 - HK0,1- HK0,2 - HK0,3 - HK0,5 - HK1 in compliance with standard ISO 6507 and ASTM E-384. User Interface by 22" full HD 10-point multi-touch desktop monitor, integrated high resolution 5.0 MP, USB 3.0 CCD camera, automatic measurement with zoom capability and automatic light brightness, with automatic test sequence by motorised turret and load motor, adjustable internal LED illumination, large sample accommodation area, emergency stop. Automatic voltage setting 100-240 V, 1-phase, 50/60 Hz.

### Standard delivery includes:

Hardness Tester, Desktop Monitor on solid stand, METKON N-Sure software incl. Auto-Measurement module, ISO/DaKks Certified Vickers diamond indenter, Objective 10x, Objective 40x, 4 adjustable tester feet, Water level indicator, Indenter protection nose, Dust Cover, Power Cable, Monitor Interface Cable, Factory Test Certificate with ISO/ASTM verifications, solid accessories box.

Note: Select below the additional XY-stage, anvils, sample fixtures and test blocks

72 02

## — DUROLINE M2

Vickers/Knoop Micro-Hardness Tester with Test & Measurement software Windows 10 "N-Sure" including Auto-Measurement module Motorized spindle Z-Axis up/down movement and Auto-Focus module Test Loads: 10, 25, 50, 100, 200, 300, 500, 1000 gf suitable for testing HV0,01 - HV0,025 - HV0,05 - HV0,1- HV0,2 - HV0,3 - HV0,5 - HV1 HK0,01 - HK0,025 - HK0,05 - HK0,1- HK0,2 - HK0,3 - HK0,5 - HK1 in compliance with standard ISO 6507 and ASTM E-384. User Interface by 22" full HD 10-point multi-touch desktop monitor, integrated high resolution 5.0 MP, USB 3.0 CCD camera, automatic motorized Z-axis and autofocus of indentations, auto-measurement with zoom capability and indent image brightness, automated test sequence by motorised turret and load motor, adjustable internal LED illumination, large sample accommodation area, emergency stop. Automatic voltage setting 100-240 V, 1-phase, 50/60 Hz.

### Standard delivery includes:

Hardness Tester, Desktop Monitor on solid stand, METKON N-Sure software incl. Auto-Measurement module, Auto-Focus module with motorised Z-axis, ISO/DaKks Certified Vickers diamond indenter, Objective 10x, Objective 40x, 4 adjustable tester feet, Water level indicator, Indenter protection nose, Dust Cover, Power Cable, Monitor Interface Cable, Factory Test Certificate with ISO/ASTM verifications, solid accessories box.

Note: Select below the additional XY-stage, anvils, sample fixtures and test blocks

72 03

## — DUROLINE M3

Vickers/Knoop Micro-Hardness Tester with Test & Measurement software Windows 10 "N-Sure" including Auto-Measurement module and large motorised XY-stage 100x150mm Test Loads: 10, 25, 50, 100, 200, 300, 500, 1000 gf suitable for testing HV0,01 - HV0,025 - HV0,05 - HV0,1- HV0,2 - HV0,3 - HV0,5 - HV1 HK0,01 - HK0,025 - HK0,05 - HK0,1- HK0,2 - HK0,3 - HK0,5 - HK1 in compliance with standard ISO 6507 and ASTM E-384. User Interface by 22" full HD 10-point multi-touch desktop monitor, integrated high resolution 5.0 MP, USB 3.0 CCD camera, motorized large XY-stage with travel 100x150 mm, auto-measurement with zoom capability and indent image brightness, automated test sequence by motorised turret and load motor, adjustable internal LED illumination, large sample accommodation area, emergency stop. Automatic voltage setting 100-240 V, 1-phase, 50/60 Hz.

### Standard delivery includes:

Hardness Tester, Desktop Monitor on solid stand, METKON N-Sure software incl. Auto-Measurement module, large motorized XY-stage, ISO/DaKks Certified Vickers diamond indenter, Objective 10x, Objective 40x, 4 adjustable tester feet, Water level indicator, Indenter protection nose, Dust Cover, Power Cable, Monitor Interface Cable, Factory Test Certificate with ISO/ASTM verifications, solid accessories box.

Note: Select below for sample fixtures and test blocks

72 04

## — DUROLINE M4

Vickers/Knoop Micro-Hardness Tester with Test & Measurement software Windows 10 "N-Sure" including Auto-Measurement module, large motorised XY-stage 100x150mm, motorized Z-axis and Auto-focus Test Loads: 10, 25, 50, 100, 200, 300, 500, 1000 gf suitable for testing HV0,01 - HV0,025 - HV0,05 - HV0,1- HV0,2 - HV0,3 - HV0,5 - HV1 HK0,01 - HK0,025 - HK0,05 - HK0,1- HK0,2 - HK0,3 - HK0,5 - HK1 in compliance with standard ISO 6507 and ASTM E-384. User Interface by 22" full HD 10-point multi-touch desktop monitor, integrated high resolution 5.0 MP, USB 3.0 CCD camera, motorized large XY-stage with travel 100x150 mm, automatic motorized Z-axis and autofocus of indentations, auto-measurement with zoom capability and indent image brightness, automated test sequence by motorised turret and load motor, adjustable internal LED illumination, large sample accommodation area, emergency stop. Automatic voltage setting 100-240 V, 1-phase, 50/60 Hz.

### Standard delivery includes:

Hardness Tester, Desktop Monitor on solid stand, METKON N-Sure software incl. Auto-Measurement module, large motorized XY-stage, ISO/DaKks Certified Vickers diamond indenter, Objective 10x, Objective 40x, 4 adjustable tester feet, Water level indicator, Indenter protection nose, Dust Cover, Power Cable, Monitor Interface Cable, Factory Test Certificate with ISO/ASTM verifications, solid accessories box.

Note: Select below for sample fixtures and test blocks

GR 2081

### Software Modules for Hardness Testing

— Software Module for CHD Testing [EHT] (Digital XY-Stage [GR2024] or Motorized stage is required) [To be ordered simultaneously with the machine order]

GR 2041  
GR 2042  
GR 2043  
GR 2044

### Object Lenses for Hardness Testing

- Object lens 5x
- Object lens 10x
- Object lens 20x
- Object lens 40x

GR 2047  
GR 2048

### Indenters for Hardness Testing

- ISO/ASTM Certificated Vickers diamond indenter
- ISO/ASTM Certificated Knoop diamond indenter

GR 2021  
GR 2022  
GR 2023

### Anvils and XY-Stages Hardness Testing

- Flat anvil diameter 80mm
- V-anvil, diameter 80mm, for cylindrical parts above 5 mm diameter
- Analogue Manual XY-stage 100x100mm, travel 25x25mm, with two analogue micrometers
- Digital Manual XY-stage 100x100mm, travel 25x25mm, with one digital Silyvac micrometer incl. cable and one analogue micrometer [GR 2081 Software Module is required for CHD/EHT testing] [To be ordered simultaneously with the machine order]

GR 2024

### Specimen Holders for Hardness Testing

- Precision vise (opening 43mm)
- Thin specimen holder
- Fine specimen holder (Horizontal type)
- Fine specimen holder (Vertical type)
- Specimen holder for Ø25 mm specimens
- Specimen holder for Ø30 mm specimens
- Specimen holder for Ø40 mm specimens
- Specimen holder for Ø50 mm specimens
- Multiple specimen holder for 6xØ25 mm specimens
- Multiple specimen holder for 6xØ30 mm specimens
- Multiple specimen holder for 6xØ40 mm specimens

GR 2061  
GR 2062  
GR 2063  
GR 2064  
GR 2065

### Verification Tools for Hardness Testing

- ISO Dakks Germany Certified standard block 200HV0.3 [30x30x6mm]
- ISO Dakks Germany Certified standard block 450HV0.3 [30x30x6mm]
- ISO Dakks Germany Certified standard block 700HV0.3 [30x30x6mm]
- ISO Dakks Germany Certified standard block 200HV1 [30x30x6mm]
- ISO Dakks Germany Certified standard block 450HV1 [30x30x6mm]
- ISO Dakks Germany Certified standard block 700HV1 [30x30x6mm]
- ISO Dakks Germany Certified standard block 200HV5 [60x60x6mm]
- ISO Dakks Germany Certified standard block 450HV5 [60x60x6mm]
- ISO Dakks Germany Certified standard block 700HV5 [60x60x6mm]
- ISO Certificated calibration scale glass.

GR 2066  
GR 2067  
GR 2068  
GR 2069  
GR 2071

\* Other voltages and frequencies available upon request. Please state when ordering. All specifications are subject to change without notice.

# DIMENSIONS

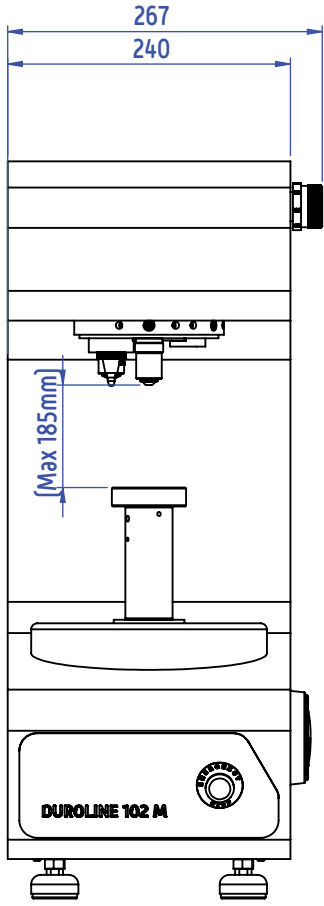
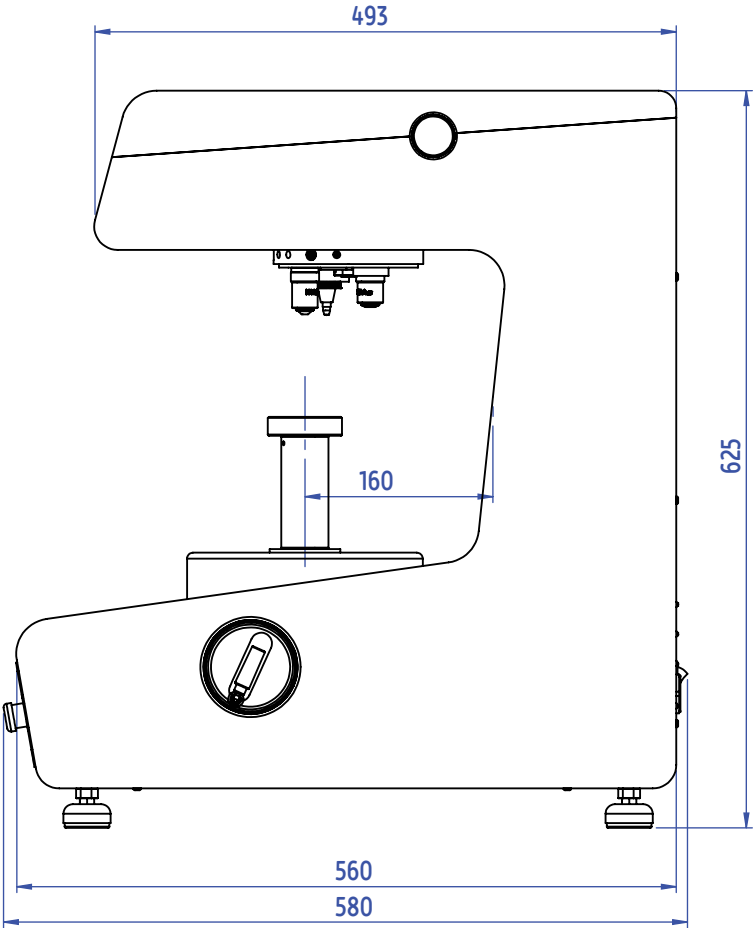



Mahr  
100 Years of Experience

DUROLINE-M

REFERENCE  
KEY

File Multi-Measurement Print Window Extras Functions Service

550.0  
HV1  
Diagonal 1: 0.08629 mm  
Diagonal 2: 0.08649 mm

Material	Method	HV1
Steel	HV1	550.0
Aluminum	HV1	550.0

Number: 31  
Range: 427.01  
Upper: 536.91  
Maximum: 570.65  
Minimum: 516.25  
Lower: 18.647  
Unit: 32.267  
ID: 487.24

Multi-Measurement

Material	Method	Range	Unit
Steel	HV1	500.0 - 950.0	
Aluminum	HV1	400.0 - 950.0	
Copper	HV1	500.0 - 950.0	
Composites	HV1	500.0 - 950.0	

0.00 X= 0.00

