

ERANST

DUROMETRI

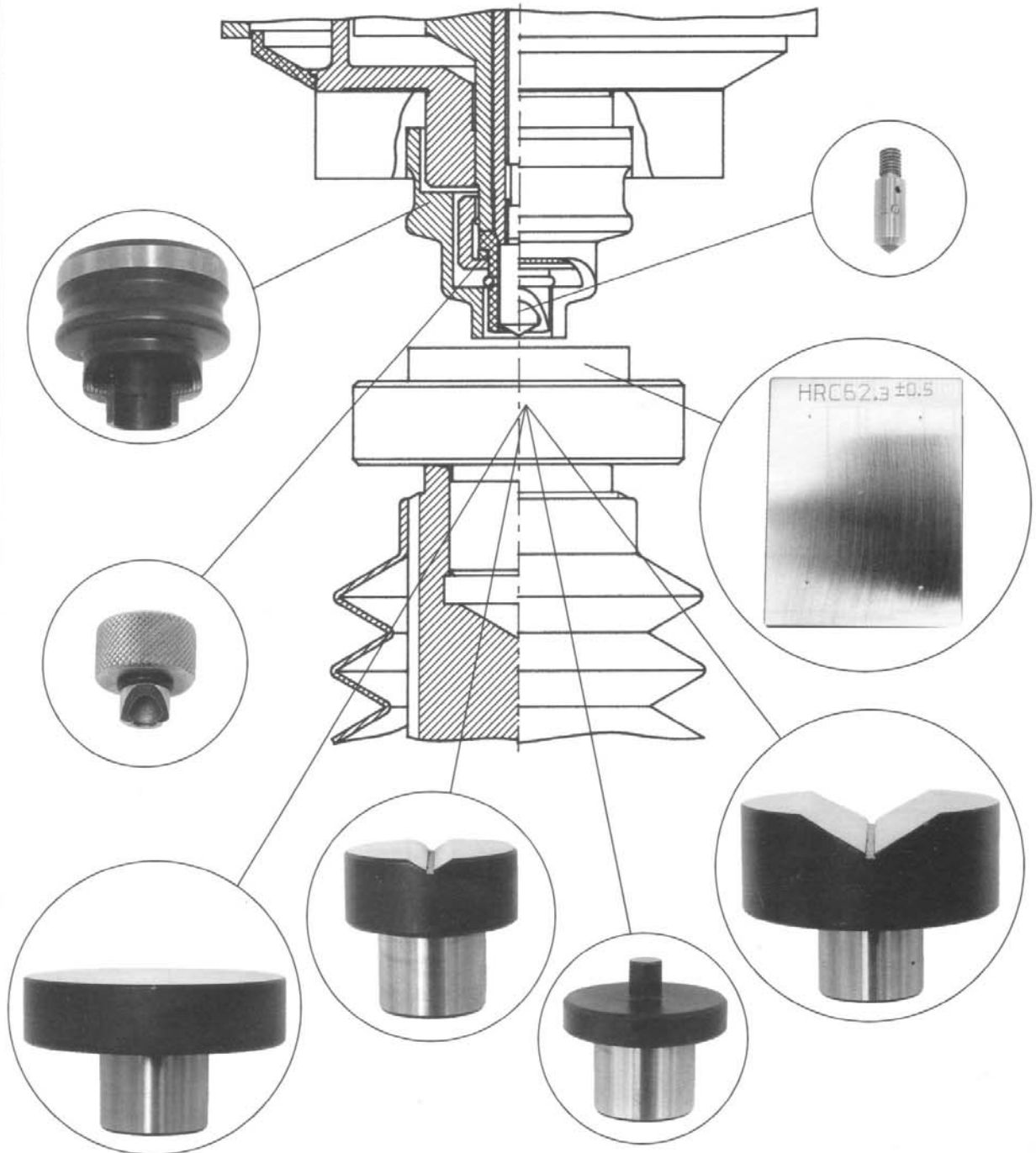

ACCESSORI

RICAMBI E ACCESSORI PER DUROMETRI ERNST

per: AT130-AT200-TWIN

Penetratore 054	Penetratore diamante HR
Penetratore 046	Penetratore diamante HV (escluso AT 130)
Penetratore 012	Penetratore con sfera fissa 1/4"
Penetratore 013	Penetratore con sfera intercambiabile 1/8"
Penetratore 008	Penetratore con sfera intercambiabile 1/16"
Penetratore 01	Penetratore con sfera intercambiabile 1 mm
Penetratore 009	Penetratore con sfera intercambiabile 2,5 mm
Penetratore 010	Penetratore con sfera intercambiabile 5 mm

per: AT130-AT200

Penetratore 048	Penetratore diamante HR esecuzione speciale
Gruppo 021	Bussola penetratore standard aperta
Gruppo 016	Bussola penetratore standard chiusa
Gruppo 022	Bussola penetratore standard 60° (solo con: <i>Penetratore 048</i>)
Gruppo 062	Pressapezzo standard aperto
Gruppo 059	Pressapezzo standard chiuso
Gruppo 032	Bussola penetratore aperta prolungata di 20 mm (*)
Gruppo 035	Bussola penetratore chiusa prolungata di 20 mm (*)
Gruppo 034	Bussola penetratore 60° prolungata di 20 mm (solo con: <i>Penetratore 048</i>)
Gruppo 057	Pressapezzo prolungato di 20 mm
Gruppo 031	Bussola penetratore aperta prolungata di 35 mm (*)
Gruppo 036	Bussola penetratore chiusa prolungata di 35 mm (*)
Gruppo 033	Bussola penetratore 60° prolungata di 35 mm (solo con: <i>Penetratore 048</i>)
Gruppo 058	Pressapezzo prolungato di 35 mm
Gruppo 029	Prolunga bussola penetratore 50 mm
Gruppo 060	Pressapezzo 50 mm
Gruppo 030	Prolunga bussola penetratore 100 mm
Gruppo 061	Pressapezzo 100 mm
Su richiesta	Rinvio per interni, dimensioni su richiesta

per: NR3-AT130-AT200-TWIN

Incudine 096	Incudine a V per toni diam. 20 mm max.
Incudine 090	Incudine a V per toni diam. 60 mm max.
Incudine 076	Incudine piana con rilievo diam. 8 mm
Incudine 083	Incudine piana diam. 60 mm
Gruppo 025	Incudine piana diam. 200 mm
Incudine 070	Incudine piana diam. 120 mm
Gruppo 024	Incudine a V per toni diam. 200 mm max.
Gruppo 038	Incudine inclinabile
Incudine 022	Incudine piana con rilievo in diamante
Su richiesta	Incudine per lame 15 mm max.
Su richiesta	Incudine per lame 80 mm max.
Riduzione 008	Riduzione per incudine piccole (codolo 10 mm)

per: STATIVO COMPUTEST

anche per: AT130-AT200-TWIN;
ma solo con: *Riduzione 008*

Incudine 001	Incudine piana diam. 20 mm
Incudine 007	Incudine piana diam. 40 mm
Incudine 013	Incudine a V per toni diam. 50 mm max.
Incudine 021	Incudine bombata
Incudine 063	Incudine piana diam. 30 mm
Incudine 028	Incudine con rilievo a punta piana diam. 5 mm
Incudine 034	Incudine a V per toni diam. 35 mm max.
Incudine 040	Incudine a V per toni diam. 6 mm max.
Incudine 045	Incudine con rilievo a punta tonda diam. 5 mm

per: NR 3

















Incudine 050	Penetratore diamante H R
Incudine 030	Penetratore con sfera intercambiabile 1/16"
Incudine 031	Penetratore con sfera intercambiabile 1/8"
Incudine 032	Penetratore con sfera intercambiabile 1/4"
Incudine 033	Penetratore con sfera fissa 1/2"
Su richiesta	Penetratore con sfera intercambiabile 1 mm
Incudine 040	Penetratore con sfera intercambiabile 2,5 mm
Incudine 029	Penetratore con sfera intercambiabile 5 mm
Su richiesta	Rinvio per interni, dimensioni su richiesta

per: STE

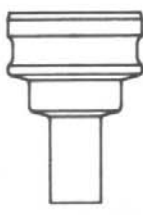
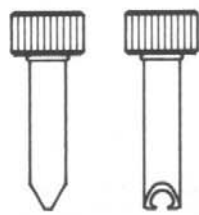
Penetratore 001	Penetratore acciaio
Penetratore 002	Penetratore carburo
Gruppo 201	Oculare 8X
Microscopio 001	Microscopio 20X con illuminazione
Microscopio 002	Microscopio 40X con illuminazione
Gruppo 048	Supporto verticale per STE/SD

PROVINI

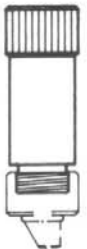
3PRV-
Provinci ERNST per controllo delle scale
(non certificati). A scelta, ottenibili su richiesta.
Attenzione: esistono solo in determinate durezza,
ognuna ottimale per la scala considerata.
Va inoltre specificato se per strumento portatile o
da banco.

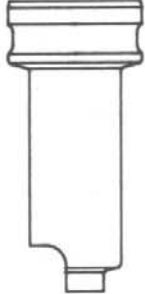
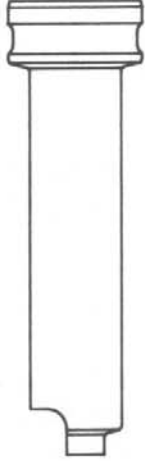
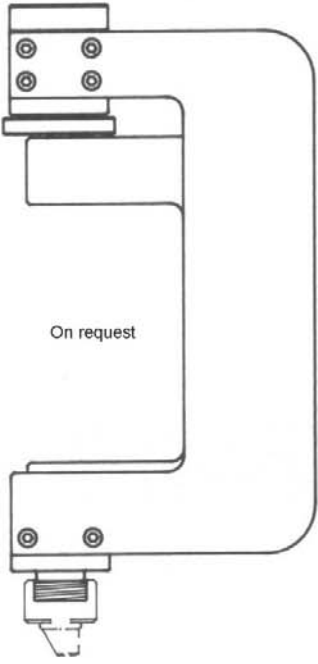
<p>Penetratore 054 Penetratore 046</p> 	<p>Penetratore 012 (1/4") Penetratore 013 (1/8") Penetratore 008 (1/16") Penetratore 01 (1 mm) Penetratore 009 (2,5 mm) Penetratore 010 (5 mm)</p>	<p>Penetratore 048</p> 		
<p>Gruppo 021</p> 	<p>Gruppo 016</p> 	<p>Gruppo 022</p> 	<p>Gruppo 062</p> 	<p>Gruppo 059</p> 
<p>Gruppo 032</p> 	<p>Gruppo 035</p> 	<p>Gruppo 034</p> 	<p>Gruppo 057</p> 	
<p>Gruppo 031</p> 	<p>Gruppo 036</p> 	<p>Gruppo 033</p> 	<p>Gruppo 058</p> 	
<p>Gruppo 029</p>  <p>Gruppo 030</p> 	<p>Gruppo 060</p>  <p>Gruppo 061</p> 		<p>On request</p> 	

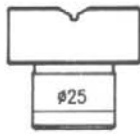

Incudine 096

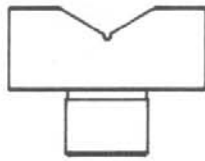

Incudine 090

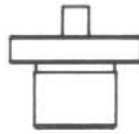

Incudine 076

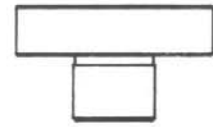

Incudine 083

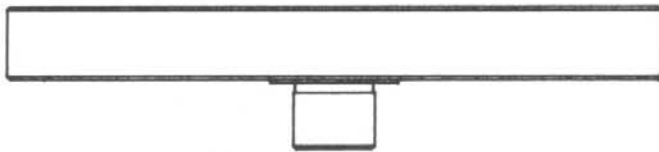

Gruppo 025

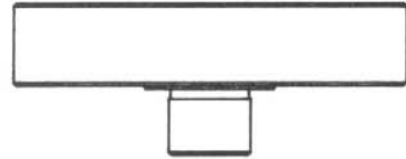

Incudine 070

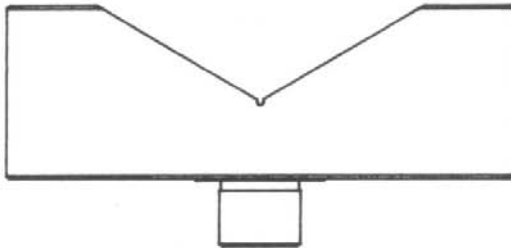

Gruppo 024

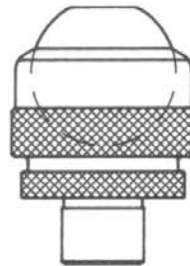

Gruppo 038

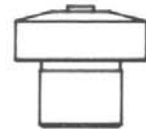

Incudine 022

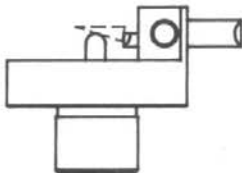

On request

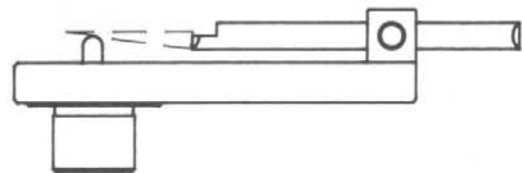

On request

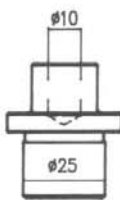

Riduzione 008



Incudine 001

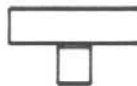

Incudine 007

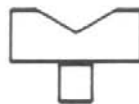

Incudine 013



Incudine 021

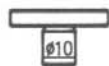

Incudine 063



Incudine 028



Incudine 034







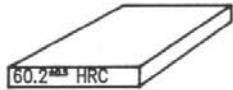

Incudine 040



Incudine 045

		 <p>60.2 HRC</p> <p>3PRV-01 (HRC) 3PRV-02 (HRB) 3PRV-03 (HB/30) 3PRV-04 (HB/10) 3PRV-05 (HB/5)</p>
--	--	---

 <p>Penetratore 050</p>  <p>Penetratore 030 (1/16") Penetratore 031 (1/8") Penetratore 032 (1/4") Penetratore 033 (1/2") On request (1 mm) Penetratore 040 (2,5 mm) Penetratore 029 (5 mm)</p>	 <p>On request</p>	 <p>Penetratore 001</p>  <p>Penetratore 002</p>  <p>Gruppo 201</p>
--	--	--

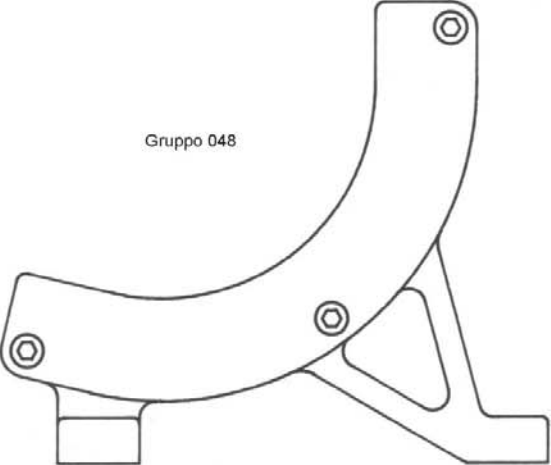
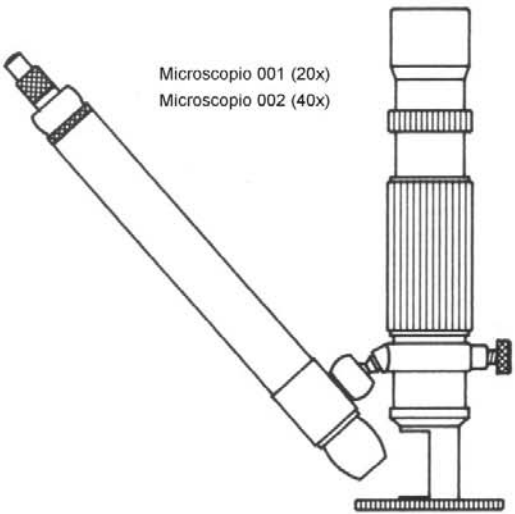
 <p>Gruppo 048</p>	 <p>Microscopio 001 (20x) Microscopio 002 (40x)</p>
---	--